

# 2020



23624 Roseberry Ave Warren, MI 48089

586-777-7167 fax 586-777-7947

[www.DetroitMuscleTechnologies.com](http://www.DetroitMuscleTechnologies.com)

## **71-74 B BODY RESTORATION GASKETS**

71-74 Dodge Charger

71-74 Plymouth GTX, Roadrunner, Satellite

**Goto [www. DetroitMuscleTechnologies.com](http://www.DetroitMuscleTechnologies.com) for  
the latest prices and new items!**

**Whats new...**

NEW DMT Hood Insulation Pads

NEW DMT Under-dash Shoddy Pad Insulation

NEW DMT Mega Firewall Gasket Kits

NEW IMPROVED DMT Firewall / kickpanel insulation kits

**Ask for our Mega Gasket List for your year/model when restoring your car**

# B Body 71-74

## Installation notes

Suggestions for replacing gaskets

- **Save old gaskets**

Recommend saving all seals and gaskets till your restoration is complete. This way you can verify the gasket / seals received match your originals. IF there are any difference between your originals and our kit I would be interested in hearing about it. I'm always learning. Contact me at [jamesfillmore@detroitmuscletechnologies.com](mailto:jamesfillmore@detroitmuscletechnologies.com)

- **Pictures**

Highly recommended to take digital pictures when removing old parts/gaskets.

- **Adhesives**

All gaskets can be attached using one of two adhesives.

For the gray charcoal foams or for applications where you don't want to "see" the adhesive, use 3M 77 Spray Adhesive. Available at most chain craft stores.

For all gray foam rubber (like taillight lense to housing gaskets) or any black foam rubber (like air grabber door to hood seals) use 3M Black Weatherstrip Adhesive. Available at most chain auto parts stores. Chrysler used very thin beads of this weatherstrip adhesive to hold gaskets in place during assembly. It's not necessary to provide a seal and will make cleaning or replacement difficult in the future. On any of the lamp lense gaskets I personally wouldn't use adhesive.



## B Body 71-74

### MEGA Gasket Sets

We have MEGA gasket checklists for each car model in either Non A/C or A/C versions. These kits combine the pieces commonly purchased when doing a repaint or restoration as well as offering a combined discount. Prices for these kits are at the bottom of the respective Paint Gasket Set pages.

#### **Mega Restoration Kits - include the following;**

- Paint gasket set
- Non firewall gasket set
- BIG Heater box resto kit
- Engine well splash shields
- Firewall insulation set with OEM style pins
- Kickpanel insulation set
- Under dash shoddy pad
- 5pc Weatherstrip set
- Mega body plug and bumper set

#### **Not included but optional;**

- Hood to radiator seals (with SS clip set)
- Hood to cowl seals with pre-installed clips





# B Body 71-74

71 Charger BASE Paint / Exterior Gasket Set BCH7171PK01 \$53.00

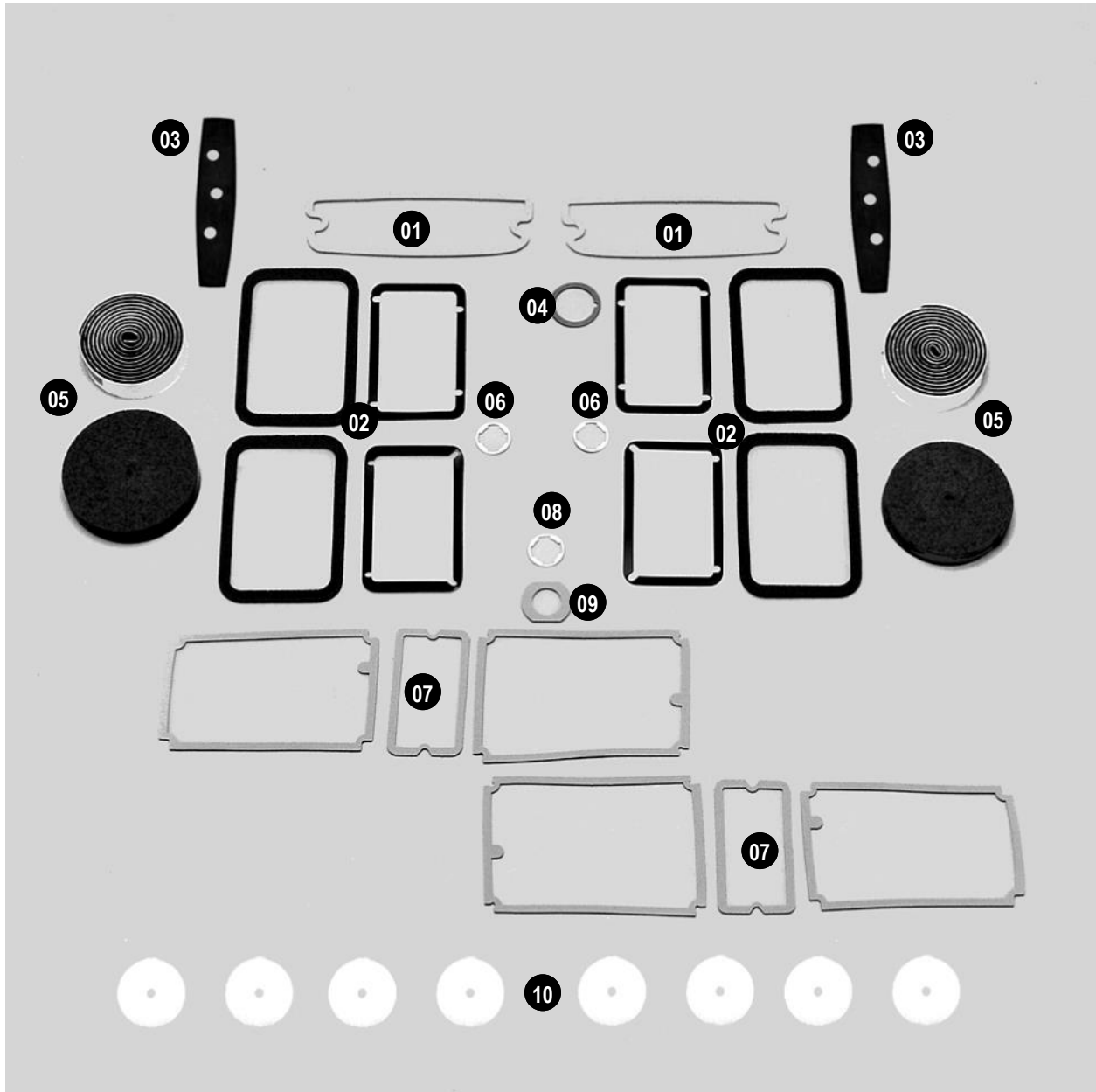

23624 Roseberry Ave Warren, MI 48089 586-777-7167 fax 586-777-7947  
[www.DetroitMuscleTechnologies.com](http://www.DetroitMuscleTechnologies.com)

## B Body 71-74

### 71 Charger BASE Paint / Exterior Gasket Set

01	71-74 Charger parking light gaskets (pair)	BCH7174PL01	\$8.00
02	71 Charger side marker gaskets (set, black plastic housing to fender, black poly foam lense to housing)	BCH7171SM01	\$12.00
03	71-72 B Body rallye mirror gaskets (pair - NOT 73-74)	ELB7174MI01	\$10.00
04	68-76 Antenna gasket	GEN6876AN01	\$1.00
05	70-74 E body & 71-74 (late) B Body weathers-strip channel and drip rail seal foam strips (4 rolls)	ELB7074DR01	\$20.00
06	62-72 lock gasket (small gray plastic, 2 req'd)	GEN6272LK01	\$1.00
07	71 Charger BASE taillight gasket set	BCH7171TL01	\$15.00
08	62-72 lock gasket (small gray plastic, 73-76 trunk lock is different / larger)	GEN6272LK01	\$1.00
09	Generic license plate light gasket (round gray foam rubber) (66-67 & 71-74 Charger, 68-74 Road Runner & Satellite, 70-72 Duster, Demon, 77-79 Lil Red Truck)	GEN6679LP01	\$1.00
10	Generic rear bumper bracket to body gaskets (8pc)	GEN6776BB01	\$4.00

**NOTE: We also have to following for your make / model;**

- A/C & Non A/C Firewall gasket sets
- A/C & Non A/C Heater box restoration gasket kits
- Firewall insulation, kickpanel insulation, shoddy pad
- Rubber splash shields sets



23624 Roseberry Ave Warren, MI 48089 586-777-7167 fax 586-777-7947  
[www.DetroitMuscleTechnologies.com](http://www.DetroitMuscleTechnologies.com)

# B Body 71-74

71 Charger R/T Paint / Exterior Gasket Set BCH7171PK02 \$56.00

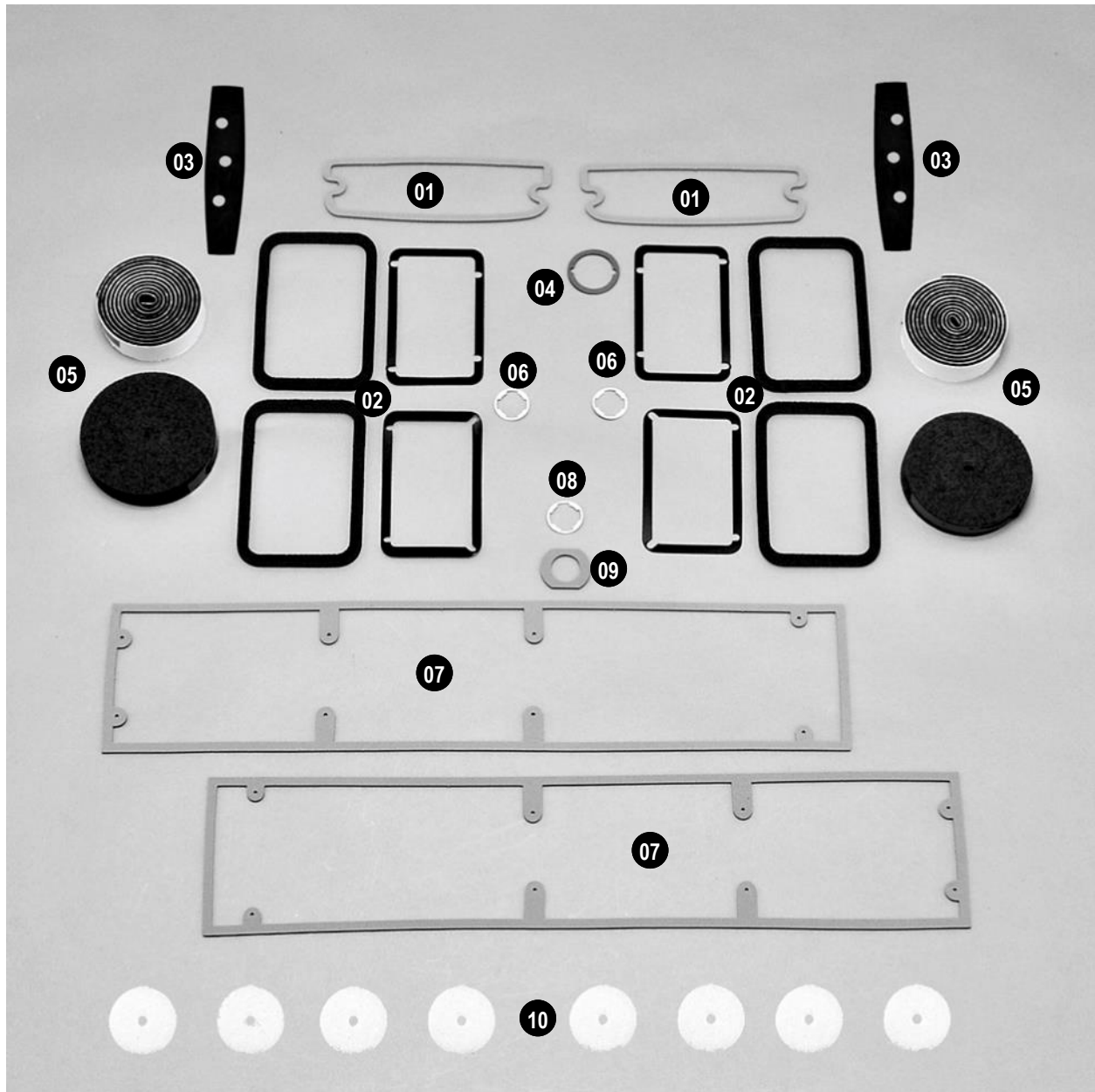

23624 Roseberry Ave Warren, MI 48089 586-777-7167 fax 586-777-7947  
[www.DetroitMuscleTechnologies.com](http://www.DetroitMuscleTechnologies.com)

## B Body 71-74

### 71 Charger R/T Paint / Exterior Gasket Set

01	71-74 Charger parking light gaskets (pair)	BCH7174PL01	\$8.00
02	71 Charger side marker gaskets (set, black plastic housing to fender, black poly foam lense to housing)	BCH7171SM01	\$12.00
03	71-72 B Body rallye mirror gaskets (pair - NOT 73-74)	ELB7174MI01	\$10.00
04	68-76 Antenna gasket	GEN6876AN01	\$1.00
05	70-74 E body & 71-74 (late) B Body weathers-strip channel and drip rail seal foam strips (4 rolls)	ELB7074DR01	\$20.00
06	62-72 lock gasket (small gray plastic, 2 req'd)	GEN6272LK01	\$1.00
07	71 Charger R/T (72 Charger Rallye) taillight gasket set	BCH7171TL02	\$18.00
08	62-72 lock gasket (small gray plastic, 73-76 trunk lock is different / larger)	GEN6272LK01	\$1.00
09	Generic license plate light gasket (round gray foam rubber) (66-67 & 71-74 Charger, 68-74 Road Runner & Satellite, 70-72 Duster, Demon, 77-79 Lil Red Truck)	GEN6679LP01	\$1.00
10	Generic rear bumper bracket to body gaskets (8pc)	GEN6776BB01	\$4.00

**NOTE: We also have to following for your make / model;**

- A/C & Non A/C Firewall gasket sets
- A/C & Non A/C Heater box restoration gasket kits
- Firewall insulation, kickpanel insulation, shoddy pad
- Rubber splash shields sets



23624 Roseberry Ave Warren, MI 48089 586-777-7167 fax 586-777-7947  
[www.DetroitMuscleTechnologies.com](http://www.DetroitMuscleTechnologies.com)



# B Body 71-74

72 Charger BASE Paint / Exterior Gasket Set BCH7272PK01 \$51.00

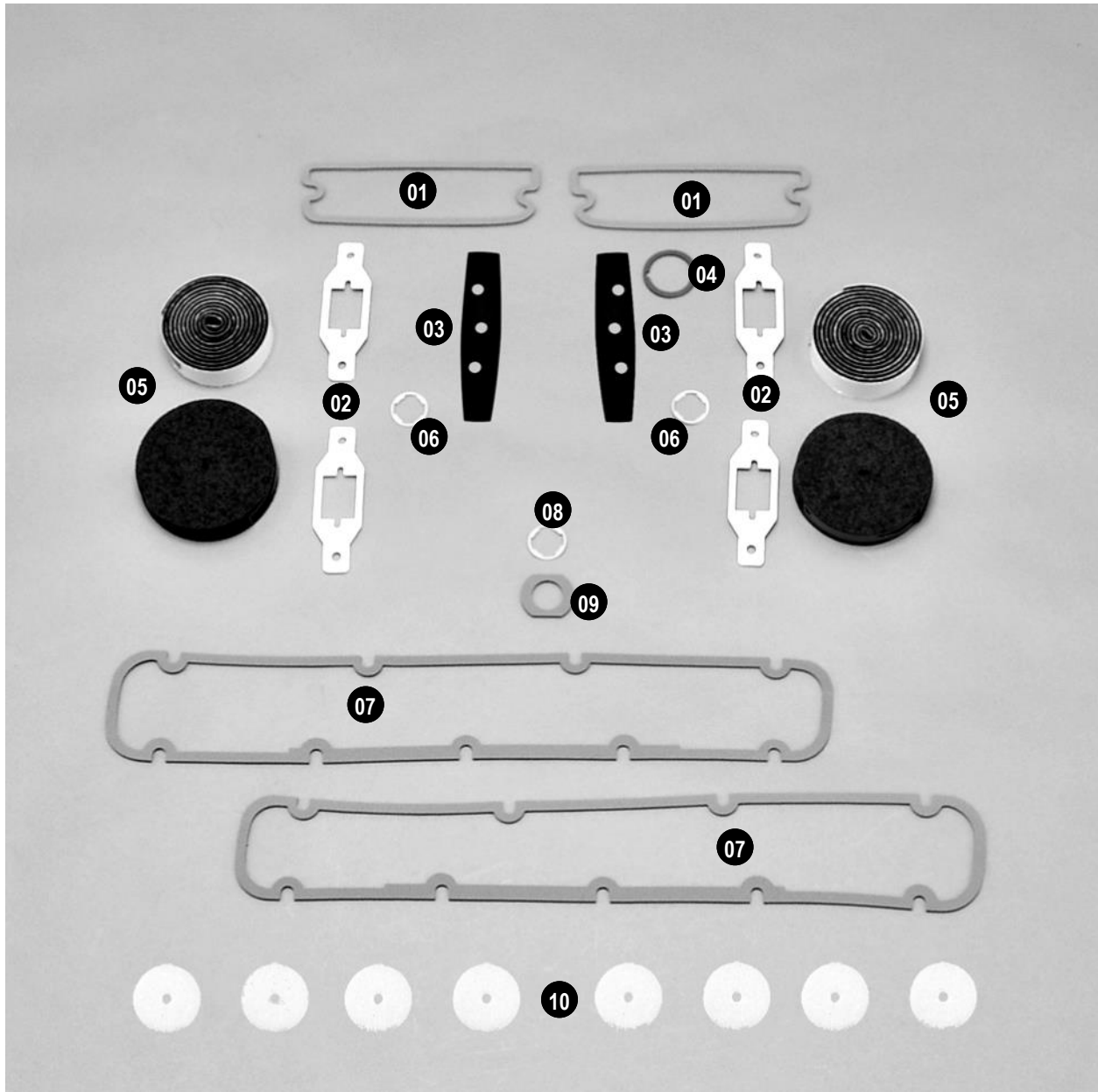

23624 Roseberry Ave Warren, MI 48089 586-777-7167 fax 586-777-7947  
[www.DetroitMuscleTechnologies.com](http://www.DetroitMuscleTechnologies.com)

## B Body 71-74

### 72 Charger BASE Paint / Exterior Gasket Set

01	71-74 Charger parking light gaskets (pair)	BCH7174PL01	\$8.00
02	72-76 Generic side marker gaskets (set)	GEN7276SM01	\$6.00
03	71-72 B Body rallye mirror gaskets (pair - NOT 73-74)	ELB7174MI01	\$10.00
04	68-76 Antenna gasket	GEN6876AN01	\$1.00
05	70-74 E body & 71-74 (late) B Body weathers-strip channel and drip rail seal foam strips (4 rolls)	ELB7074DR01	\$20.00
06	62-72 lock gasket (small gray plastic, 2 req'd)	GEN6272LK01	\$1.00
07	72 Charger BASE taillight gasket set	BCH7272TL01	\$15.00
08	62-72 lock gasket (small gray plastic, 73-76 trunk lock is different / larger)	GEN6272LK01	\$1.00
09	Generic license plate light gasket (round gray foam rubber) (66-67 & 71-74 Charger, 68-74 Road Runner & Satellite, 70-72 Duster, Demon, 77-79 Lil Red Truck)	GEN6679LP01	\$1.00
10	Generic rear bumper bracket to body gaskets (8pc)	GEN6776BB01	\$4.00

**NOTE: We also have to following for your make / model;**

- A/C & Non A/C Firewall gasket sets
- A/C & Non A/C Heater box restoration gasket kits
- Firewall insulation, kickpanel insulation, shoddy pad
- Rubber splash shields sets



23624 Roseberry Ave Warren, MI 48089 586-777-7167 fax 586-777-7947  
[www.DetroitMuscleTechnologies.com](http://www.DetroitMuscleTechnologies.com)

# B Body 71-74

72 Charger RALLYE Paint / Exterior Gasket Set BCH7272PK02 \$ 51.00

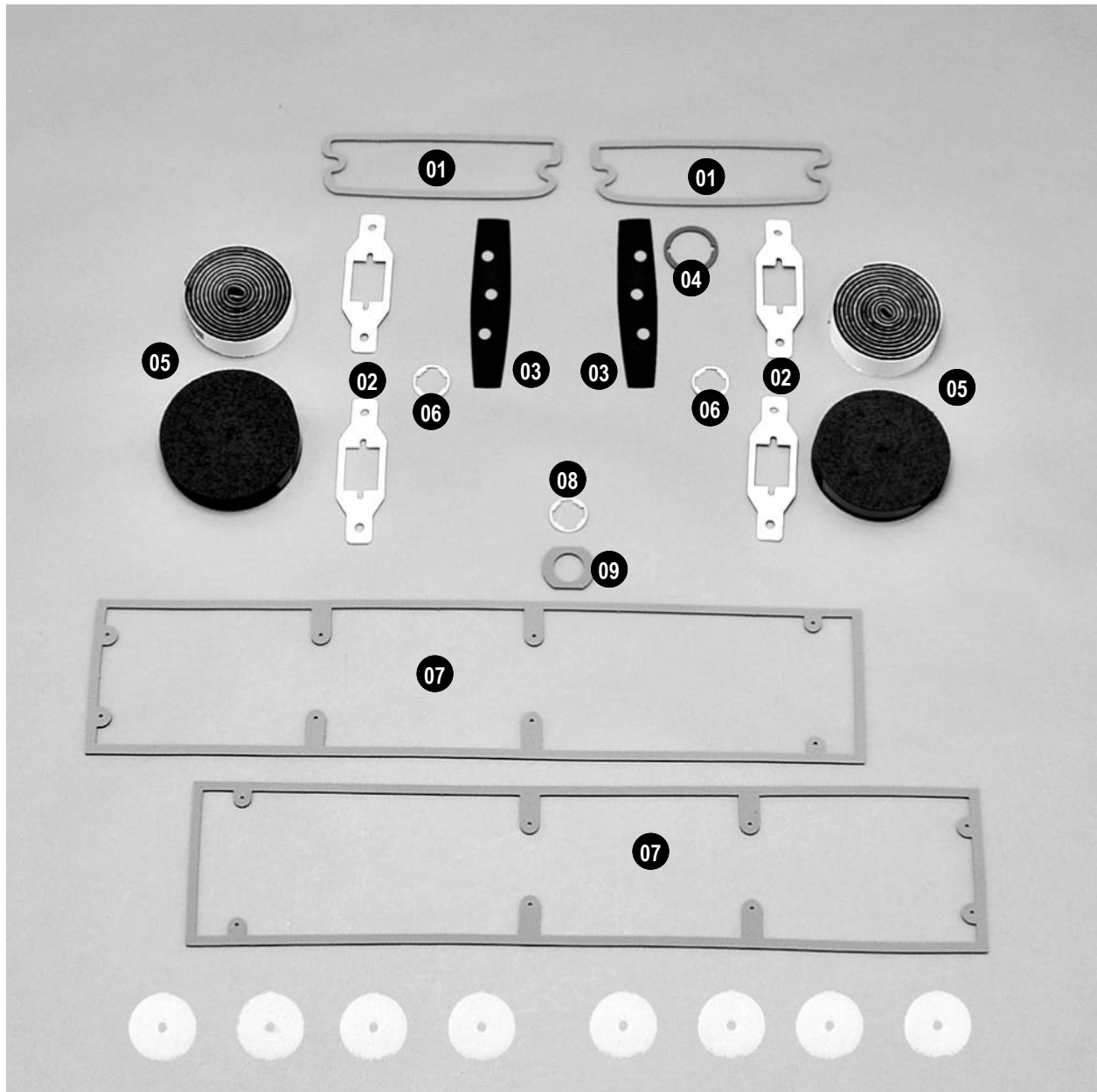

## B Body 71-74

### 72 Charger RALLYE Paint / Exterior Gasket Set

01	71-74 Charger parking light gaskets (pair)	BCH7174PL01	\$8.00
02	72-76 Generic side marker gaskets (set)	GEN7276SM01	\$6.00
03	71-72 B Body rallye mirror gaskets (pair - NOT 73-74)	ELB7174MI01	\$10.00
04	68-76 Antenna gasket	GEN6876AN01	\$1.00
05	70-74 E body & 71-74 (late) B Body weathers-strip channel and drip rail seal foam strips (4 rolls)	ELB7074DR01	\$20.00
06	62-72 lock gasket (small gray plastic, 2 req'd)	GEN6272LK01	\$1.00
07	71 Charger R/T (72 Charger Rallye) taillight gasket set	BCH7171TL02	\$18.00
08	62-72 lock gasket (small gray plastic, 73-76 trunk lock is different / larger)	GEN6272LK01	\$1.00
09	Generic license plate light gasket (round gray foam rubber) (66-67 & 71-74 Charger, 68-74 Road Runner & Satellite, 70-72 Duster, Demon, 77-79 Lil Red Truck)	GEN6474LP01	\$1.00
10	Generic rear bumper bracket to body gaskets (8pc)	GEN6776BB01	\$4.00

**NOTE: We also have to following for your make / model;**

- A/C & Non A/C Firewall gasket sets
- A/C & Non A/C Heater box restoration gasket kits
- Firewall insulation, kickpanel insulation, shoddy pad
- Rubber splash shields sets



23624 Roseberry Ave Warren, MI 48089 586-777-7167 fax 586-777-7947  
[www.DetroitMuscleTechnologies.com](http://www.DetroitMuscleTechnologies.com)

# B Body 71-74

73-74 Charger Paint / Exterior Gasket Set BCH7374PK01 \$46.00

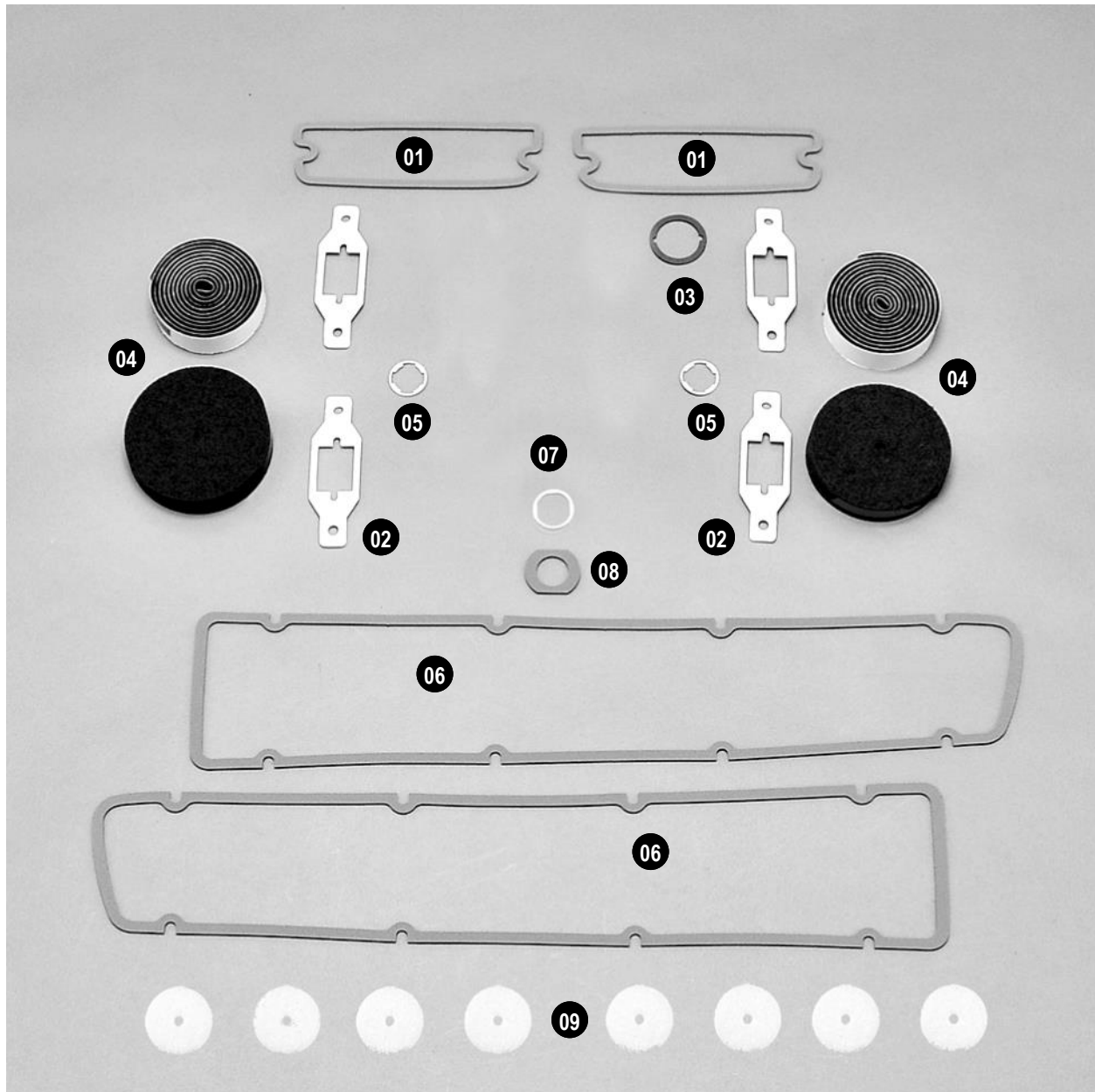

23624 Roseberry Ave Warren, MI 48089 586-777-7167 fax 586-777-7947  
[www.DetroitMuscleTechnologies.com](http://www.DetroitMuscleTechnologies.com)

## B Body 71-74

### 73-74 Charger Exterior / Paint Set Gaskets

01	71-74 Charger parking light gaskets (pair)	BCH7174PL01	\$8.00
02	72-76 Generic side marker gaskets (set)	GEN7276SM01	\$6.00
03	68-76 Antenna gasket	GEN6876AN01	\$1.00
04	70-74 E body & 71-74 (late) B Body weathers-strip channel and drip rail seal foam strips (4 rolls)	ELB7074DR01	\$20.00
05	62-72 lock gasket (small gray plastic, 2 req'd)	GEN6272LK01	\$1.00
06	73-74 Charger taillight gasket set	BCH7374TL02	\$15.00
07	73 Trunk lock gasket (large gray plastic)	GEN7376LK01	\$1.00
08	Generic license plate light gasket (round gray foam rubber) (66-67 & 71-74 Charger, 68-74 Road Runner & Satellite, 70-72 Duster, Demon, 77-79 Lil Red Truck)	GEN6679LP01	\$1.00
09	Generic rear bumper bracket to body gaskets (8pc)	GEN6776BB01	\$4.00

**NOTE: We also have to following for your make / model;**

- A/C & Non A/C Firewall gasket sets
- A/C & Non A/C Heater box restoration gasket kits
- Firewall insulation, kickpanel insulation, shoddy pad
- Rubber splash shields sets



23624 Roseberry Ave Warren, MI 48089 586-777-7167 fax 586-777-7947  
[www.DetroitMuscleTechnologies.com](http://www.DetroitMuscleTechnologies.com)

# B Body 71-74

71 Satellite Paint / Exterior Gasket Set BSA7171PK01 \$51.00

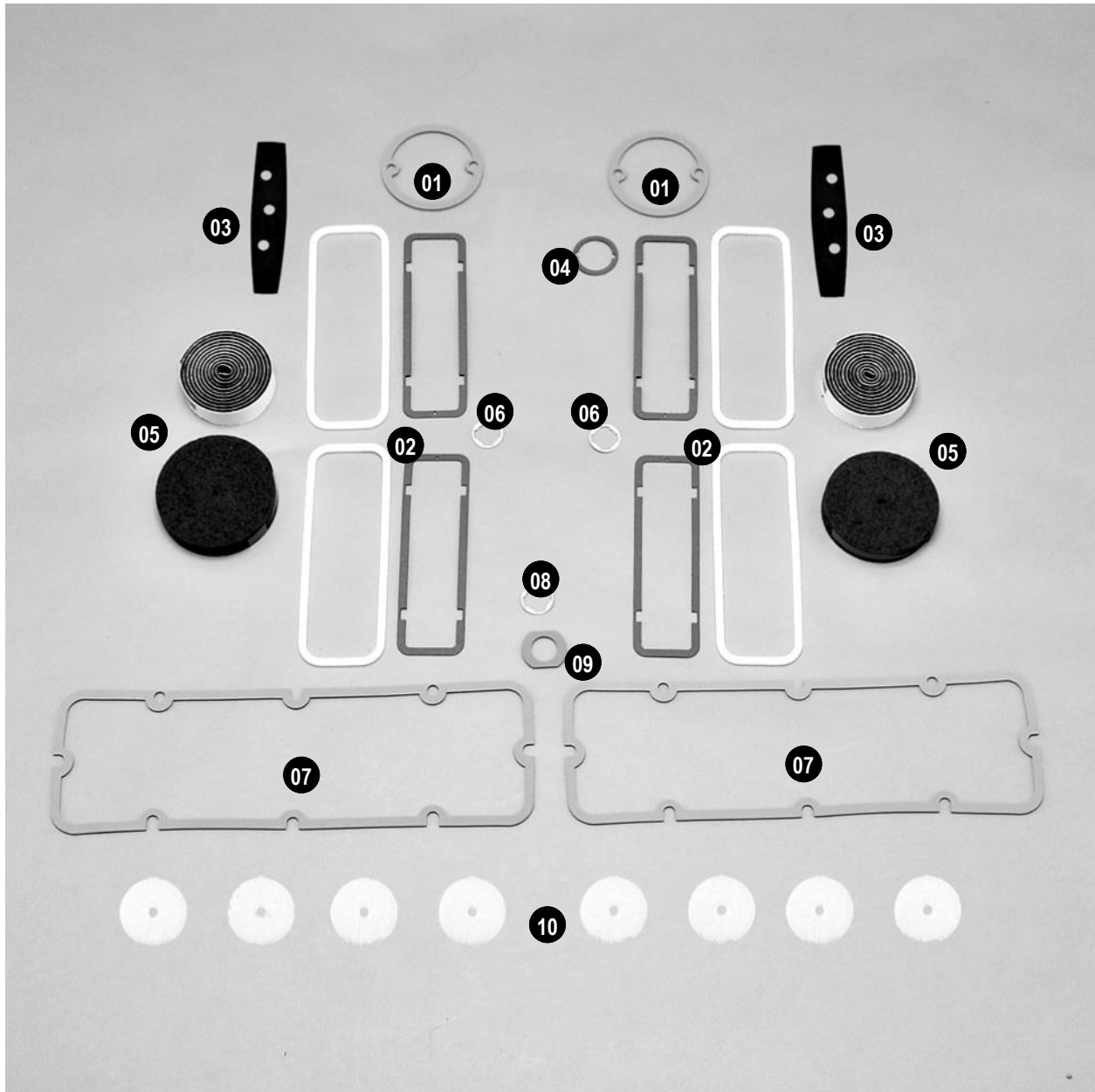

23624 Roseberry Ave Warren, MI 48089 586-777-7167 fax 586-777-7947  
[www.DetroitMuscleTechnologies.com](http://www.DetroitMuscleTechnologies.com)

## B Body 71-74

### 71 Satellite Paint / Exterior Gasket Set

01	71-72 Satellite parking light gaskets (pair)	BSA7172PL01	\$8.00
02	71 Satellite side marker gaskets (set, black plastic housing to fender, white poly foam lense to housing)	BSA7171SM01	\$10.00
03	71-72 B Body rallye mirror gaskets (pair - NOT 73-74)	ELB7174MI01	\$10.00
04	68-76 Antenna gasket	GEN6876AN01	\$1.00
05	70-74 E body & 71-74 (late) B Body weathers-strip channel and drip rail seal foam strips (4 rolls)	ELB7074DR01	\$20.00
06	62-72 lock gasket (small gray plastic, 2 req'd)	GEN6272LK01	\$1.00
07	71 Satellite taillight gasket set	BSA7171TL01	\$15.00
08	62-72 lock gasket (small gray plastic, 73-76 trunk lock is different / larger)	GEN6272LK01	\$1.00
09	Generic license plate light gasket (round gray foam rubber) (66-67 & 71-74 Charger, 68-74 Road Runner & Satellite, 70-72 Duster, Demon, 77-79 Lil Red Truck)	GEN6679LP01	\$1.00
10	Generic rear bumper bracket to body gaskets (8pc)	GEN6776BB01	\$4.00

**NOTE: We also have to following for your make / model;**

- A/C & Non A/C Firewall gasket sets
- A/C & Non A/C Heater box restoration gasket kits
- Firewall insulation, kickpanel insulation, shoddy pad
- Rubber splash shields sets



23624 Roseberry Ave Warren, MI 48089 586-777-7167 fax 586-777-7947  
[www.DetroitMuscleTechnologies.com](http://www.DetroitMuscleTechnologies.com)



# B Body 71-74

72 Satellite Exterior / Paint Gasket Set BSA7272PK01 \$57.00

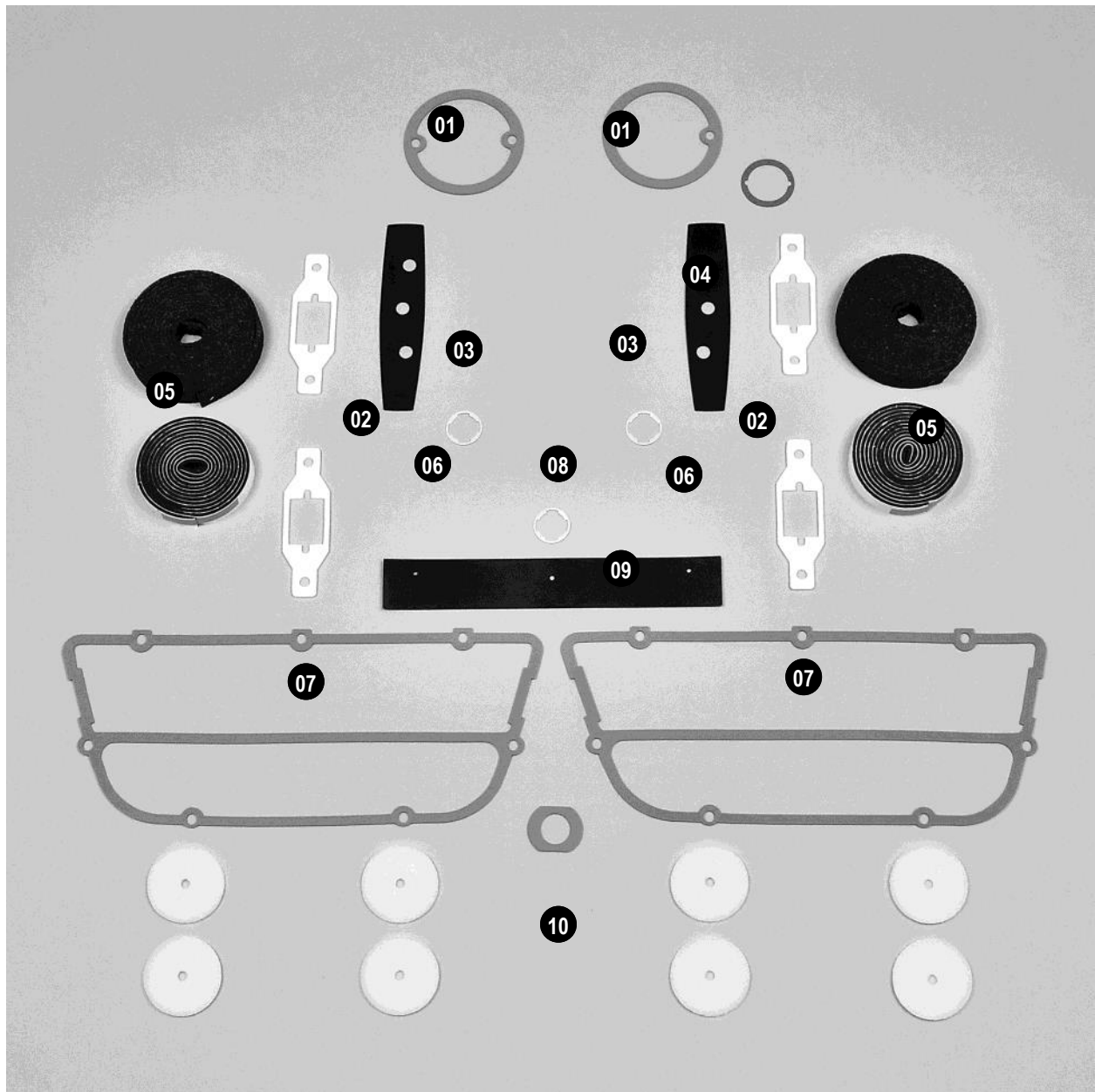

23624 Roseberry Ave Warren, MI 48089 586-777-7167 fax 586-777-7947  
[www.DetroitMuscleTechnologies.com](http://www.DetroitMuscleTechnologies.com)

## B Body 71-74

### 72 Satellite Paint / Exterior Gasket Set

01	71-72 Satellite parking light gaskets (pair)	BSA7174PL01	\$8.00
02	72-76 Generic side marker gaskets (set)	GEN7276SM01	\$6.00
03	71-72 B Body rallye mirror gaskets (pair - NOT 73-74)	ELB7174MI01	\$10.00
04	68-76 Antenna gasket	GEN6876AN01	\$1.00
05	70-74 E body & 71-74 (late) B Body weathers-strip channel and drip rail seal foam strips (4 rolls)	ELB7074DR01	\$20.00
06	62-72 lock gasket (small gray plastic, 2 req'd)	GEN6272LK01	\$1.00
07	72 Satellite taillight gasket set	BSA7272TL01	\$15.00
08	62-72 lock gasket (small gray plastic, 73-76 trunk lock is different / larger)	GEN6272LK01	\$1.00
09	Generic license plate light gasket (round gray foam rubber) (66-67 & 71-74 Charger, 68-74 Road Runner & Satellite, 70-72 Duster, Demon, 77-79 Lil Red Truck)	GEN6679LP01	\$1.00
10	Generic rear bumper bracket to body gaskets (8pc)	GEN6776BB01	\$4.00

**NOTE: We also have to following for your make / model;**

- A/C & Non A/C Firewall gasket sets
- A/C & Non A/C Heater box restoration gasket kits
- Firewall insulation, kickpanel insulation, shoddy pad
- Rubber splash shields sets



23624 Roseberry Ave Warren, MI 48089 586-777-7167 fax 586-777-7947  
[www.DetroitMuscleTechnologies.com](http://www.DetroitMuscleTechnologies.com)

# B Body 71-74

73-74 Satellite Exterior / Paint Gasket Set BSA7374PK01 \$45.00

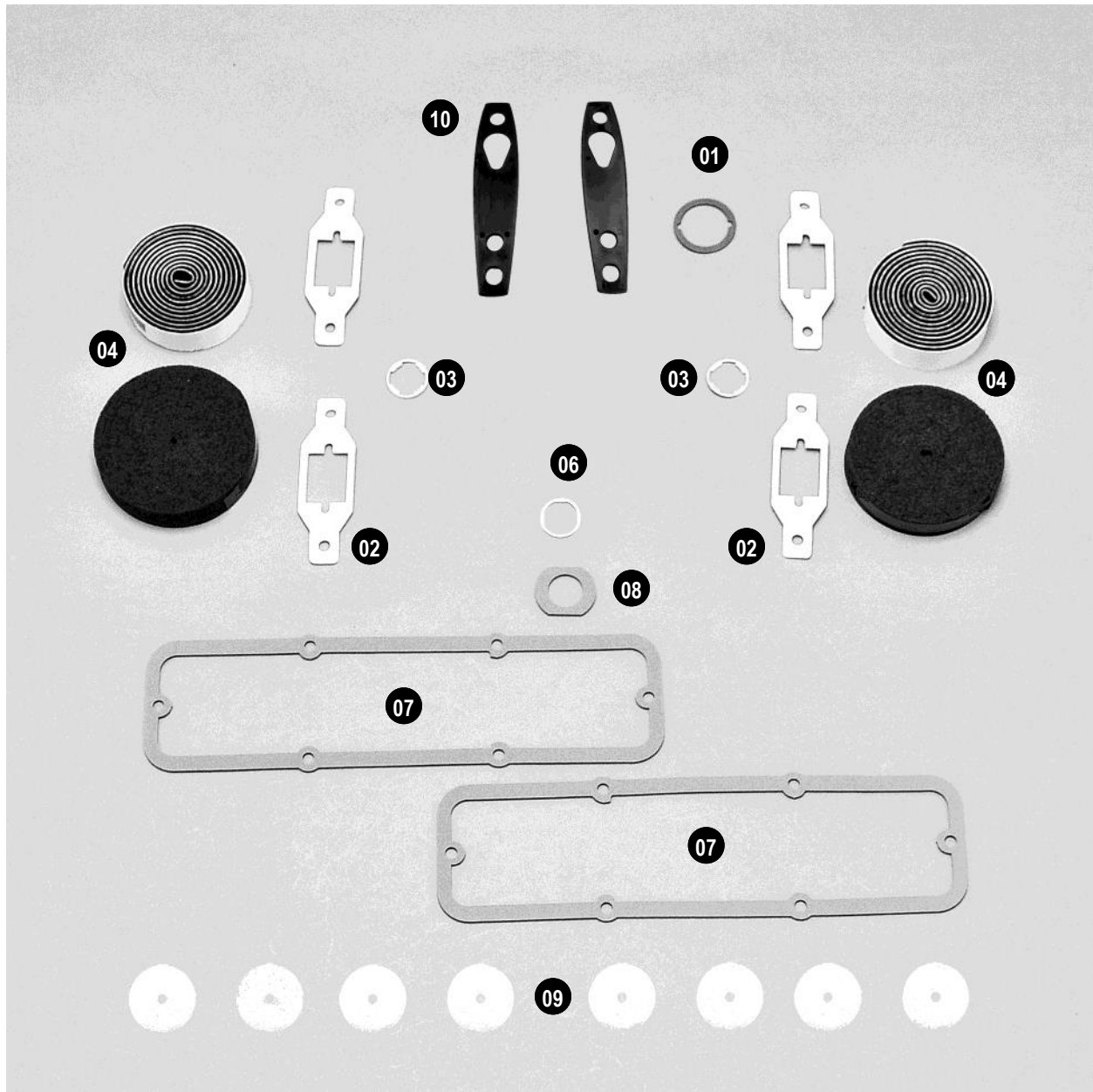

23624 Roseberry Ave Warren, MI 48089 586-777-7167 fax 586-777-7947  
[www.DetroitMuscleTechnologies.com](http://www.DetroitMuscleTechnologies.com)

## B Body 71-74

### 72 Satellite Paint / Exterior Gasket Set

01	68-76 Antenna gasket	GEN6876AN01	\$1.00
02	72-76 Generic side marker gaskets (set)	GEN7276SM01	\$6.00
03	62-72 lock gasket (small gray plastic, 2 req'd)	GEN6272LK01	\$1.00
04	70-74 E body & 71-74 (late) B Body weathers-strip channel and drip rail seal foam strips (4 rolls)	ELB7074DR01	\$20.00
05			
06	72 Satellite taillight gasket set	BSA7272TL01	\$15.00
07	73-76 Trunk lock gasket (large gray plastic)	GEN7376LK01	\$1.00
08	Generic license plate light gasket (round gray foam rubber) (66-67 & 71-74 Charger, 68-74 Road Runner & Satellite, 70-72 Duster, Demon, 77-79 Lil Red Truck)	GEN6679LP01	\$1.00
09	Generic rear bumper bracket to body gaskets (8pc)	GEN6776BB01	\$4.00
10	73-74 B Body mirror gasket (pair)	BXX7374MI02	\$9.00
10a	73-74 B Body mirror gasket (single)	BXX7374MI01	\$5.00

**NOTE: We also have to following for your make / model;**

- A/C & Non A/C Firewall gasket sets
- A/C & Non A/C Heater box restoration gasket kits
- Firewall insulation, kickpanel insulation, shoddy pad
- Rubber splash shields sets



23624 Roseberry Ave Warren, MI 48089 586-777-7167 fax 586-777-7947  
[www.DetroitMuscleTechnologies.com](http://www.DetroitMuscleTechnologies.com)

# B Body 71-74

## 71-74 Charger misc

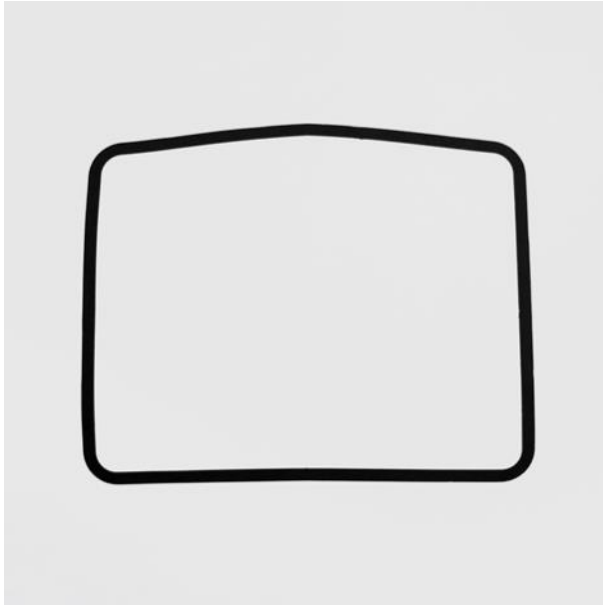

**BXX7072AG02** **\$10.00**

**71-72 Charger 70 Roadrunner air grabber box to hood seal**

Seals air grabber door to recess in hood. 71-72 RR is different. Comes to more of a point.

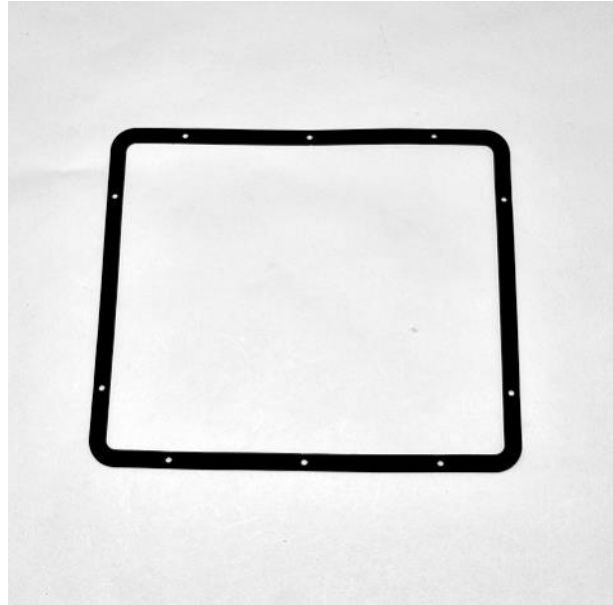

**BXX7072AG01** **\$10.00**

**71-72 Charger, 70-72 Roadrunner air grabber box to underside of hood seal**

Seals air grabber box to underside of hood



**BXX6972AG01** **\$90.00**

**71-72 Charger, 69-70 Coronet 70-72 Roadrunner air grabber box to air cleaner base seal**

Firm rubber with metal supports on edges.



**BXX7174SP01** **\$18.00**

**B Body 71-74 Under Cowl Shoddy Pad**

3/8" thick shoddy sound deadener insulation attached under cowl with 3M 90 spray adhesive

## B Body 71-74

### 71-74 Roadrunner, Satellite misc



**BSA7172AG01**

**\$10.00**

**71-72 Satellite Roadrunner air grabber box to hood seal**

Seals air grabber door to recess in hood. 71-72 Charger is different. Seal is more square.

## B Body 71-74

71-72 Charger MEGA Splash Shield Set BCH7172SS90 \$34.00

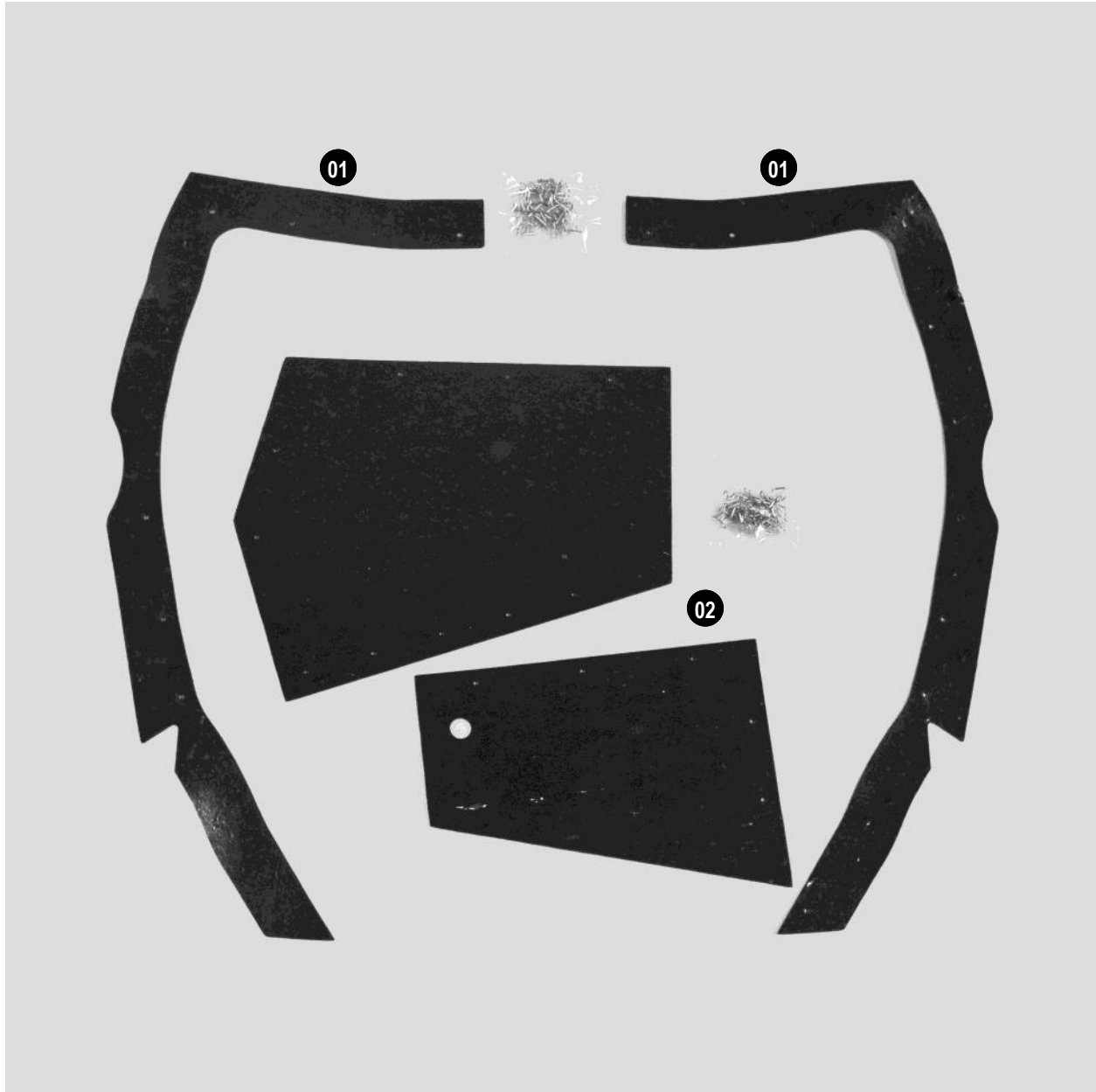

23624 Roseberry Ave Warren, MI 48089 586-777-7167 fax 586-777-7947  
[www.DetroitMuscleTechnologies.com](http://www.DetroitMuscleTechnologies.com)

## B Body 71-74

### 71-72 Charger Splash Shields

<b>01</b>	<b>71-74 Charger headlight splash shield</b> (with OEM style stainless steel push pins)	<b>BCH7174SS10</b>	<b>\$20.00</b>
<b>02</b>	<b>71-72 Charger &amp; 71-72 Satellite engine well splash shields</b> (with OEM style stainless steel push pins)	<b>BXX7172SS20</b>	<b>\$18.00</b>



23624 Roseberry Ave Warren, MI 48089 586-777-7167 fax 586-777-7947  
[www.DetroitMuscleTechnologies.com](http://www.DetroitMuscleTechnologies.com)



# B Body 71-74

73-74 Charger MEGA Splash Shield Set BCH7374SS90 \$40.00

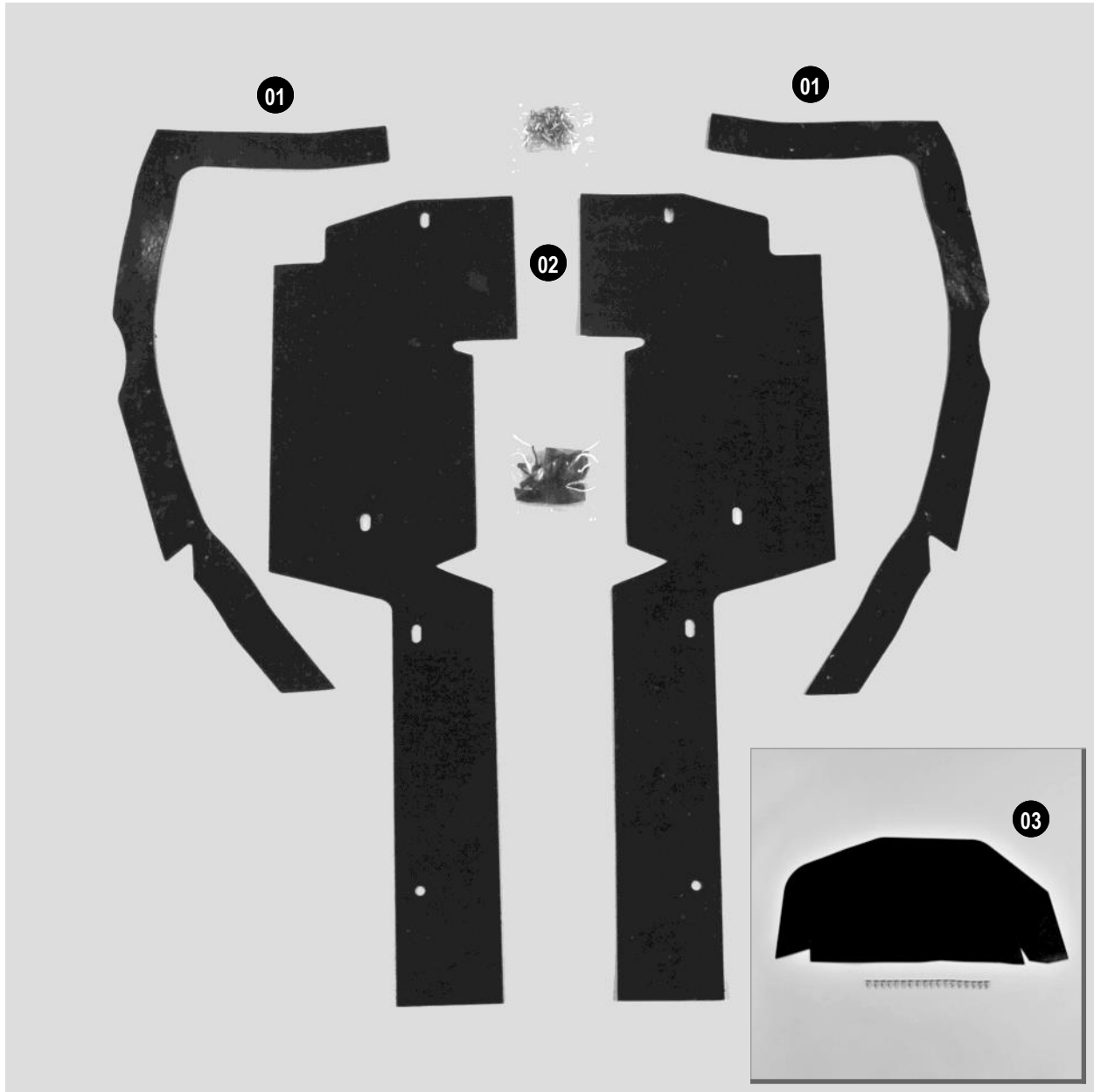

23624 Roseberry Ave Warren, MI 48089 586-777-7167 fax 586-777-7947  
[www.DetroitMuscleTechnologies.com](http://www.DetroitMuscleTechnologies.com)

## B Body 71-74

### 73-74 Charger Splash Shields

<b>01</b>	<b>71-74 Charger headlight splash shield</b> (with OEM style stainless steel push pins)	<b>BCH7174SS10</b>	<b>\$20.00</b>
<b>02</b>	<b>73-74 Charger radiator side splash shields</b> (with OEM style plastic push pins)	<b>BCH7374SS30</b>	<b>\$24.00</b>
<b>Optional</b>			
<b>03a</b>	<b>73-74 Charger passengers side engine well splash shield</b> <b>only for cars with factor big block (400") engines</b> (3/32" firm rubber - not masticated - with OEM style stainless steel push pins)	<b>BCH7374SS20</b>	<b>\$18.00</b>
<b>03b</b>	<b>73-74 Charger passengers side engine well splash shield</b> <b>only for cars with factor big block (400") engines</b> (3/32" HIGH TEMP AIRCRAFT QUALITY SILICONE RUBBER with OEM style stainless steel push pins)	<b>BCH7374SS21</b>	<b>\$59.00</b>



## B Body 71-74

71-72 Satellite MEGA Splash Shield Set BSA7172SS90 \$54.00

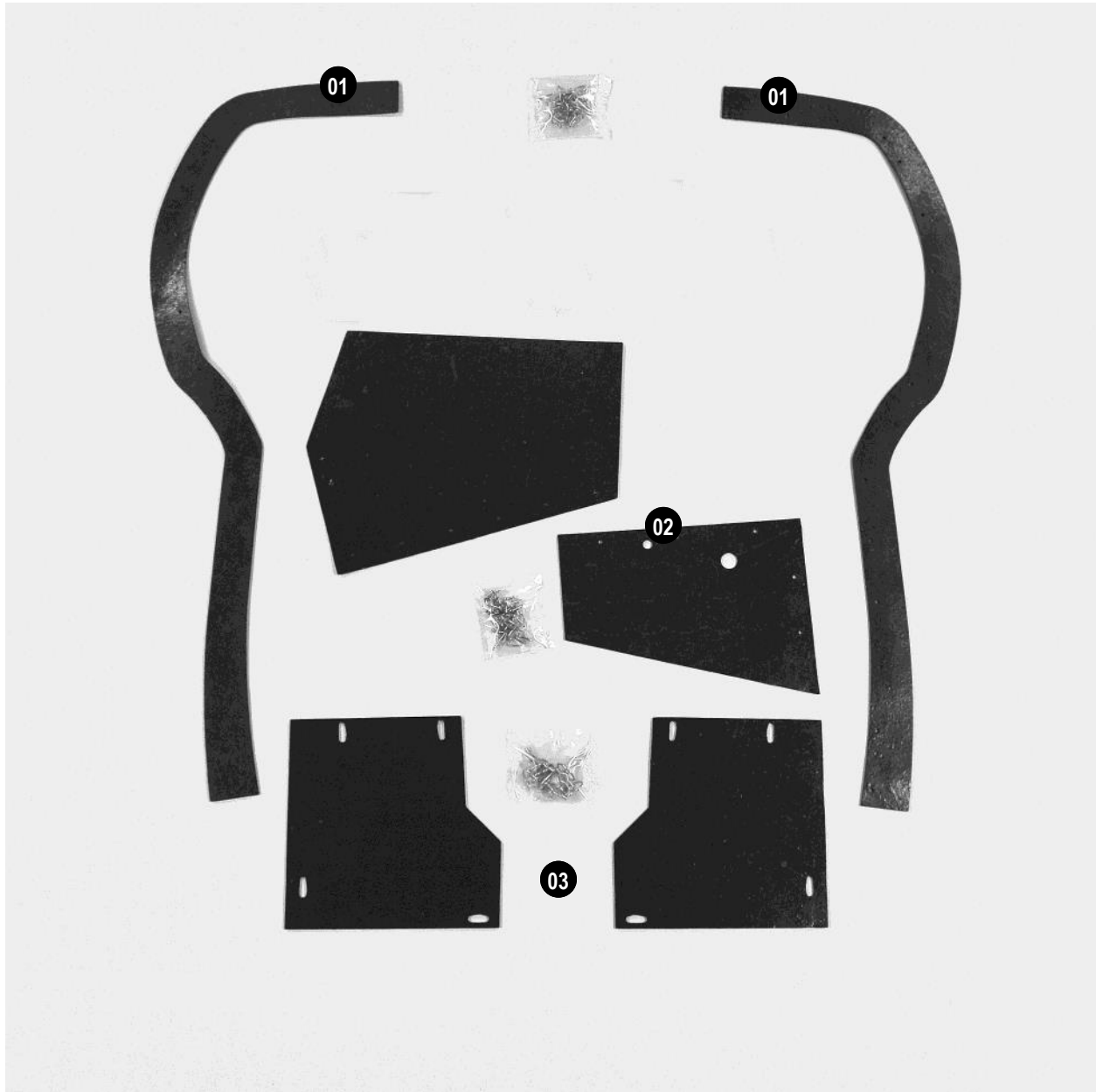

## B Body 71-74

### 71-72 Satellite Splash Shields

<b>01</b>	<b>71-72 Satellite headlight splash shield</b> (with OEM style stainless steel push pins)	<b>BSA7172SS10</b>	<b>\$20.00</b>
<b>02</b>	<b>71-72 Charger &amp; 71-72 Satellite engine well splash shields</b> (with OEM style stainless steel push pins)	<b>BXX7172SS20</b>	<b>\$18.00</b>
<b>03</b>	<b>71-71-72 Satellite front bumper bracket splash shields</b> (with large, round head OEM style stainless steel push pins)	<b>BSA7172SS40</b>	<b>\$12.00</b>



23624 Roseberry Ave Warren, MI 48089 586-777-7167 fax 586-777-7947  
[www.DetroitMuscleTechnologies.com](http://www.DetroitMuscleTechnologies.com)

# B Body 71-74

Non A/C Firewall Gasket Set BXX7174FW01 \$30.00

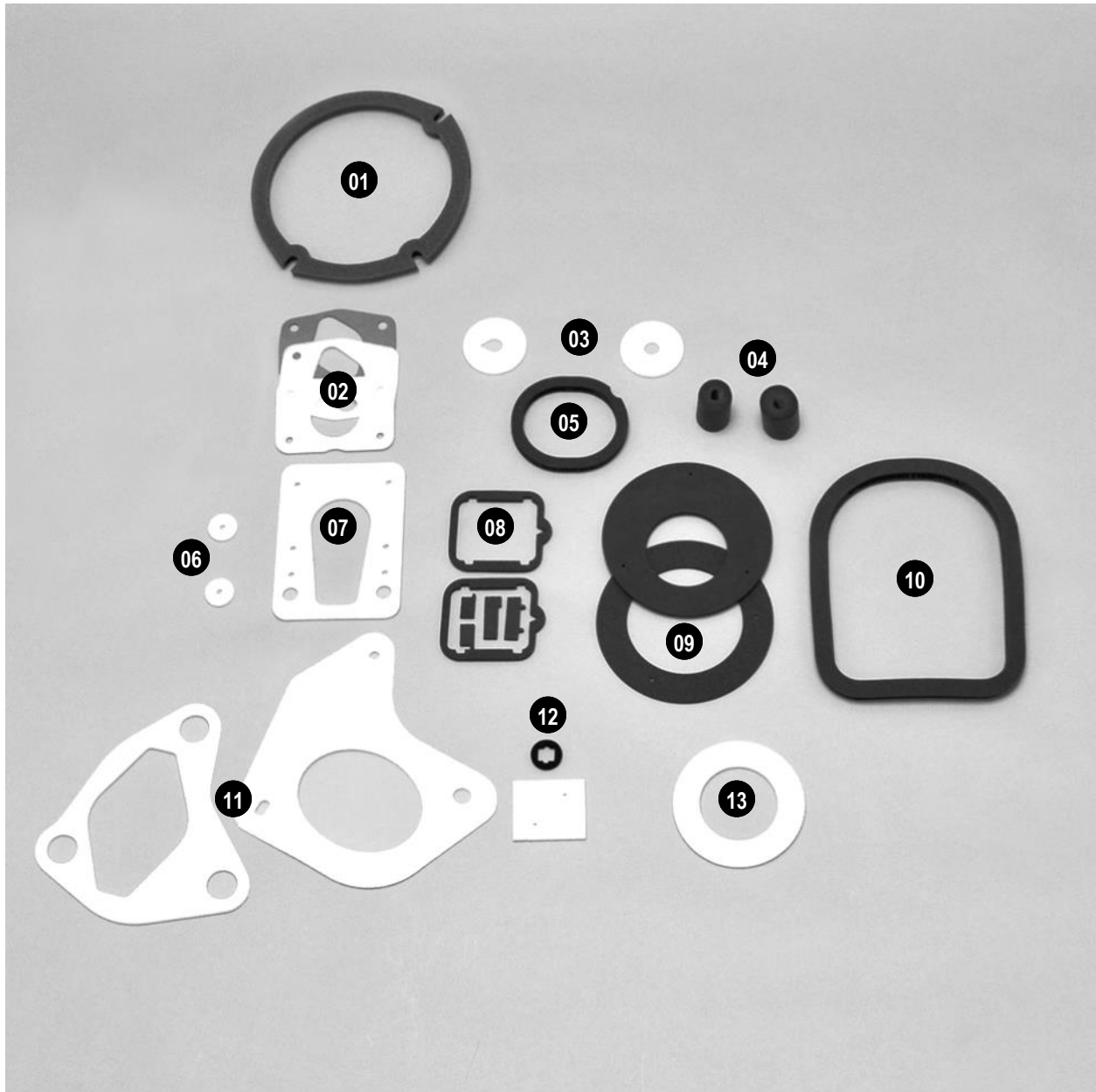

23624 Roseberry Ave Warren, MI 48089 586-777-7167 fax 586-777-7947  
[www.DetroitMuscleTechnologies.com](http://www.DetroitMuscleTechnologies.com)

## B Body 71-74

### Non A/C Firewall Gaskets

01	70-74 E Body & 71-74 (late) B Body drivers side fresh air vent to cowl seal	ELB7074FV01	\$4.00
02	Generic master cylinder gaskets set (3pcs to cover all different applications)	GEN6676MC01	\$6.00
03	70-74 E Body & 71-74 (late) B Body wiper pivot to cowl seals (white poly foam)	ELB7071WP01	\$4.00
04	70-74 E body & 71-74 (late) B Body heater core tubes to firewall seals (1 large, 1 small)	N/A	N/A
05	Generic wiper motor to cowl seal (black foam rubber)	GEN6676WM01	\$3.00
06	Generic clutch pedal stud seals (pair white poly foam)		
07	70-74 E Body & 71-74 (late) B Body brake booster to firewall gasket (white poly foam)	ELB7074BB01	\$4.00
08	70-74 E Body & 71-74 (late) B Body electrical bulkhead connector seal set (black foam rubber)	ELB7074BH01	\$6.00
09a	70-74 E Body & 71-74 (late) B Body non A/C heater box blower motor to firewall seal (black foam rubber, large hole black foam, typically 72-74)	ELB7074HB22	\$4.00
09b	70-74 E Body & 71-74 (late) B Body non A/C heater box blower motor to firewall seal (black foam rubber, small hole black foam, typically 70-71)	ELB7074HB23	\$4.00
10	70-74 E Body & 71-74 (late) B Body non A/C heater box to cowl seal (1/2" thick "D" shaped black foam rubber)	ELB7074HB21	\$6.00
11a	73-74 Body steering column to firewall seal (OEM style fine texture white poly foam - large round hole)	BXX7374SC01	\$4.00
11b	72-74 E Body & 71-72 (late) B Body steering column to firewall gasket (OEM style fine texture white poly foam)	ELB7274SC01	\$4.00
12	70-74 E Body & 71-74 (late) B Body accel pedal to firewall gasket (black foam rubber cable seal, white poly bracket to firewall)	ELB7074AP01	\$3.00
13	70-74 E Body & 71-74 (late) auto trans (slap stick) linkage to trans tunnel gasket (white poly foam)	ELB7074SL01	\$2.00



# B Body 71-74

A/C Firewall Gasket Set BXX7174FW10 \$30.00

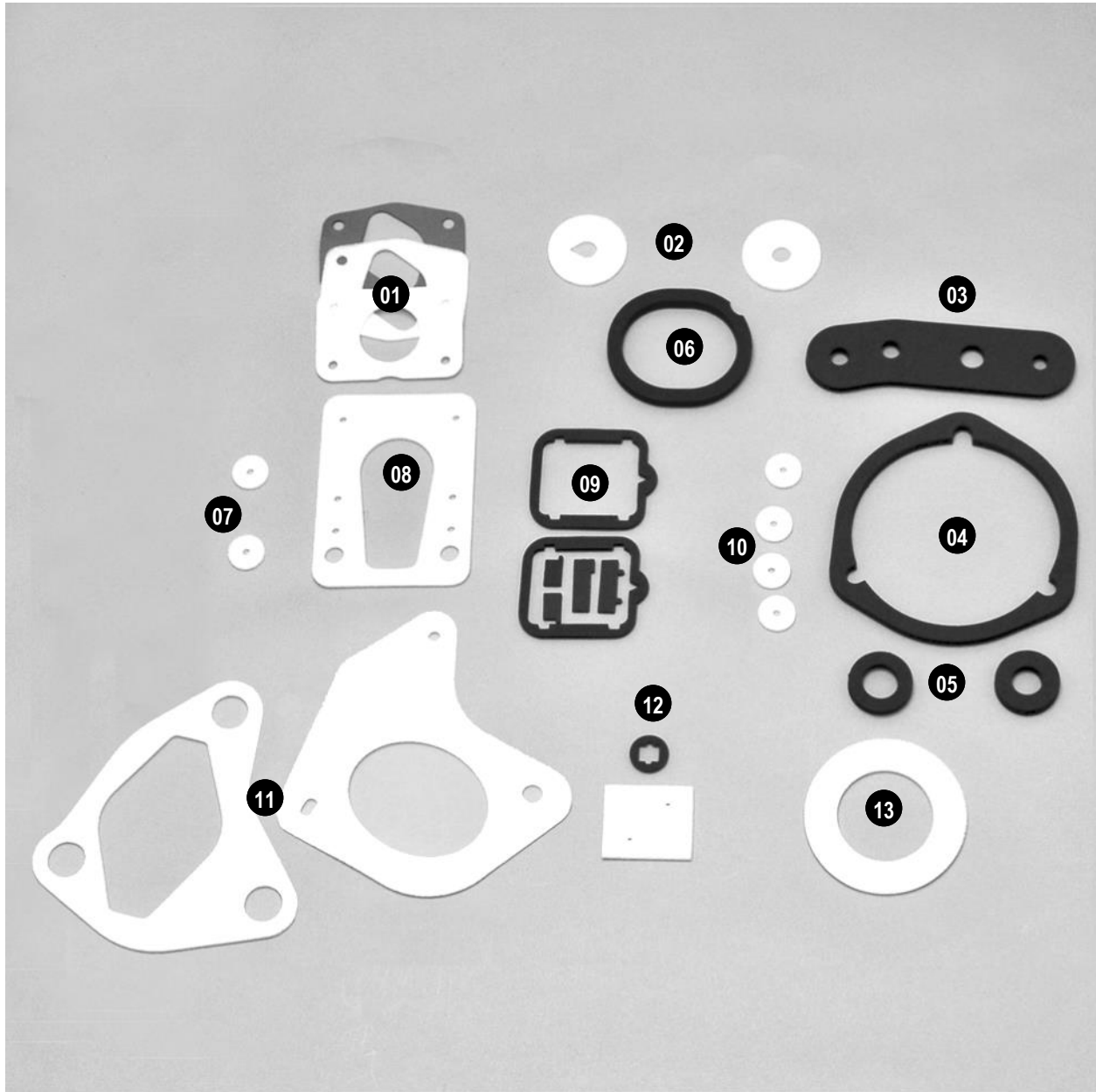

14218 9 Mile Rd Warren, MI 48089 586-777-7167 fax 586-777-7947

[www.DetroitMuscleTechnologies.com](http://www.DetroitMuscleTechnologies.com)

20024 ROSEBERRY AVE WARREN, MI 48093 508-111-1101 fax 508-111-1947

[www.DetroitMuscleTechnologies.com](http://www.DetroitMuscleTechnologies.com)

## B Body 71-74

### A/C Firewall Gaskets

01	Generic master cylinder gaskets set (3pcs to cover all different applications)	GEN6676MC01	\$6.00
02	70-74 E Body & 71-74 (late) B Body wiper pivot to cowl seals (white poly foam)	ELB7071WP01	\$4.00
03	70-74 E body & 71-74 (late) B Body A/C evaporator tubes to firewall seal (black foam rubber)	ELB7074HB32	\$6.00
04	70-74 E body & 71-74 (late) B Body A/C blower motor to firewall seal (black foam rubber)	ELB7074HB33	\$8.00
05	70-74 E body & 71-74 (late) B Body A/C blower motor to firewall drain seals (black foam rubber donuts)	N/A	N/A
06	Generic wiper motor to cowl seal (black foam rubber)	GEN6676WM01	\$3.00
07	Generic clutch pedal stud seals (pair white poly foam)		
08	70-74 E Body & 71-74 (late) B Body brake booster to firewall gasket (white poly foam)	ELB7074BB01	\$4.00
09	70-74 E Body & 71-74 (late) B Body electrical bulkhead connector seal set (black foam rubber)	ELB7074BH01	\$6.00
10	70-74 E Body & 71-74 (late) B Body A/C heater box to firewall stud seals (white poly foam donuts)	N/A	N/A
11a	73-74 Body steering column to firewall seal (OEM style fine texture white poly foam - large round hole)	BXX7374SC01	\$4.00
11b	72-74 E Body & 71-72 (late) B Body steering column to firewall gasket (OEM style fine texture white poly foam)	ELB7274SC01	\$4.00
12	70-74 E Body & 71-74 (late) B Body accel pedal to firewall seal (black foam rubber cable seal, white poly bracket to firewall)	ELB7074AP01	\$2.00
13	70-74 E Body & 71-74 (late) auto trans (slap stick) linkage to trans tunnel gasket (white poly foam)	ELB7074SL01	\$2.00





# B Body 71-74

## NON AC firewall & kickpanel insulation

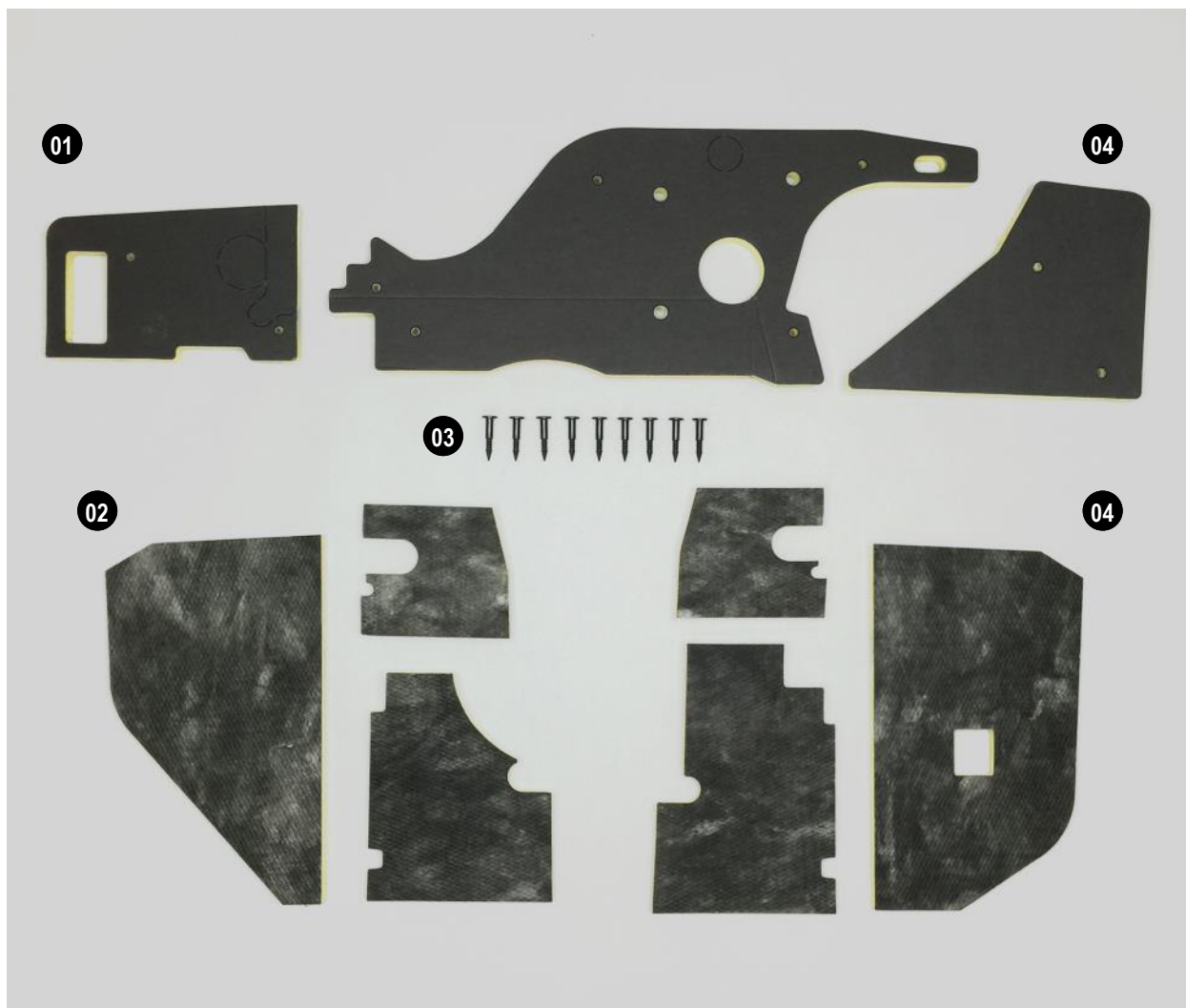

01	B Body 71-74 BASIC Non AC Firewall Insulation With (9) OEM style pins	BXX7174FI01	\$42.00
02	B Body 71-74 BASIC Kickpanel Insulation	BXX7174KI01	\$22.00
03	A Body 66-74, B Body 67-72, C Body 66-73, E Body 70-74 OEM style firewall insulation pins - EACH	GEN6674FP01-1	\$1.50
04	<b>B Body 71-74 BASIC Non AC Firewall &amp; Kickpanel Insulation</b> Set with OEM style pins	<b>BXX7174FI02</b>	<b>\$58.00</b>

# B Body 71-74

## AC firewall & kickpanel insulation

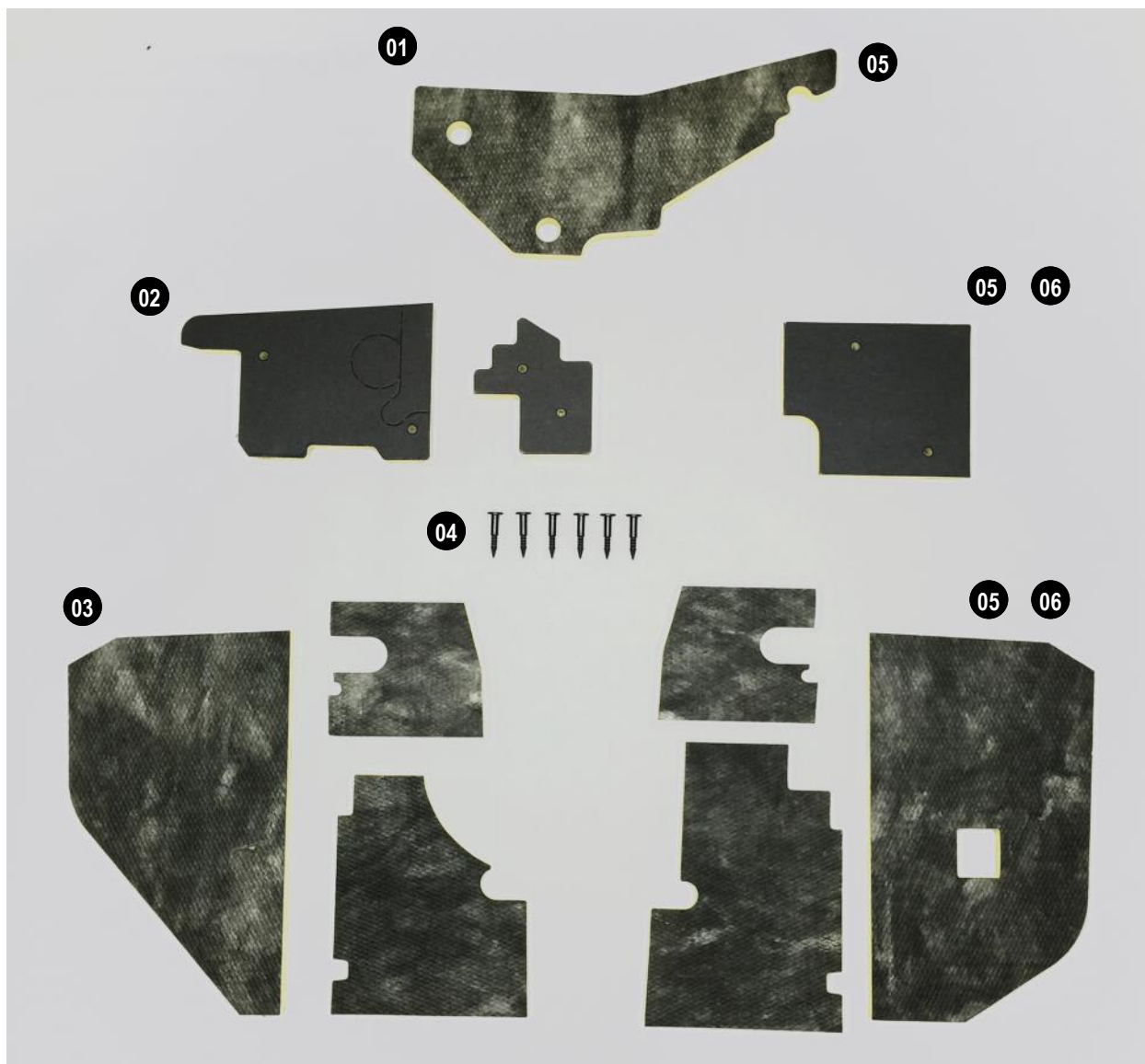

01	E Body 70-74, B Body 71-74 Insulation on back of AC box	ELB7074HB19	\$6.00
02	E Body 70-74, B Body 71-74 BASIC 3pc AC Firewall Insulation With OEM style pins	ELB7074F110	\$28.00
03	B Body 71-74 BASIC 6pc Kickpanel Insulation	BXX7174KI01	\$22.00
04	A Body 66-74, B Body 67-72, C Body 66-73, E Body 70-74 OEM style firewall insulation pins - EACH	GEN6674FP01-1	\$1.50
05	<b>B Body 71-74 AC Firewall &amp; Kickpanel Insulation Set</b> With OEM style pins <b>WITH</b> insulation piece for back of AC box	<b>BXX7174FW12</b>	<b>\$52.00</b>
06	<b>B Body 71-74 AC Firewall &amp; Kickpanel Insulation Set</b> With OEM style pins <b>WITHOUT</b> insulation piece for back of AC box	<b>BXX7174FW14</b>	<b>\$48.00</b>

# B Body 71-74

Non A/C Heater Box Resto Set BXX7174HB01 \$40.00

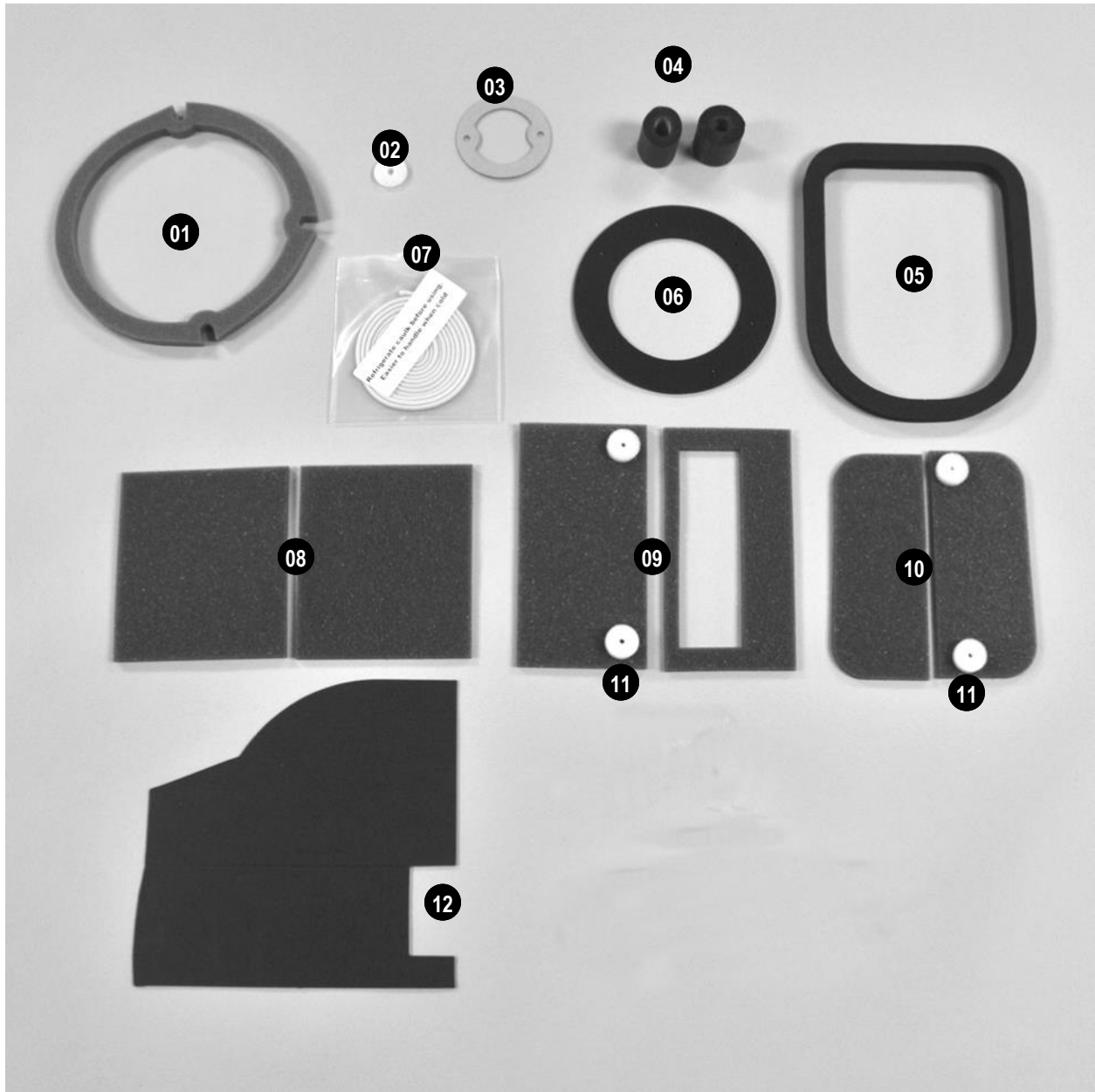

## B Body 71-74

### Non A/C Heater Box Gasket Set

01	70-74 E Body & 71-74 (late) B Body drivers side fresh air vent to cowl seal	ELB7074FV01	\$4.00
02	Firewall stud seal(1pc white poly donut)	N/A	N/A
03	70-74 E Body & 71-74 (late) blower motor to backplate gasket (thick tan paper)	ELB7074HB20	\$2.00
04	70-74 E body & 71-74 (late) B Body heater core tubes to firewall seals (1 large, 1 small)	N/A	N/A
05	70-74 E Body & 71-74 (late) B Body non A/C heater box to cowl seal (1/2" thick "D" shaped black foam rubber)	ELB7074HB21	\$6.00
06	70-74 E Body & 71-74 (late) B Body non A/C heater box blower motor to firewall seal (black foam rubber, large hole black foam, typically 72-74)	ELB7074HB22	\$4.00
07	Generic white strip caulk	N/A	N/A
08	Door foams (charcoal foam)	N/A	N/A
09	Door foams (charcoal foam)	N/A	N/A
10	Fresh air door foams (charcoal foam)	N/A	N/A
11	Door anti rattle bushings (4pcs thick white poly foam)	N/A	N/A
12	Black cardboard floor vent deflector	ELB7074HB21	\$10.00



23624 Roseberry Ave Warren, MI 48089 586-777-7167 fax 586-777-7947  
[www.DetroitMuscleTechnologies.com](http://www.DetroitMuscleTechnologies.com)

# B Body 71-74

**BIG** Non A/C Heater Box Resto Kit BXX7174HB02 \$64.00

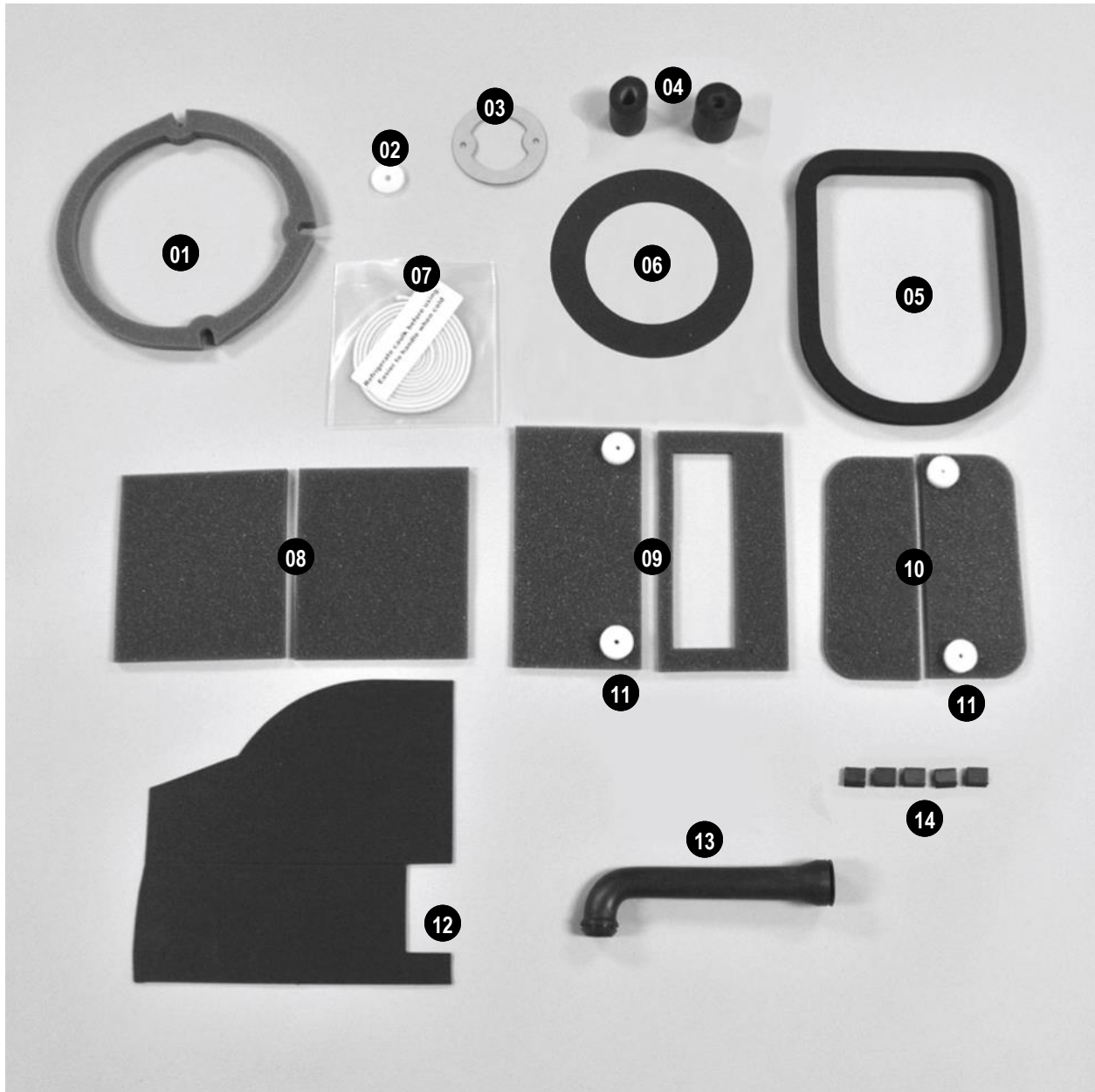

23624 Roseberry Ave Warren, MI 48089 586-777-7167 fax 586-777-7947  
[www.DetroitMuscleTechnologies.com](http://www.DetroitMuscleTechnologies.com)

## B Body 71-74

### BIG Non A/C Heater Box Gasket Set

01	70-74 E Body & 71-74 (late) B Body drivers side fresh air vent to cowl seal	ELB7074HB24	\$4.00
02	Firewall stud seal(1pc white poly donut)	N/A	N/A
03	70-74 E Body & 71-74 (late) blower motor to backplate gasket (thick tan paper)	ELB7074HB26	\$2.00
04	70-74 E Body & 71-74 (late) B Body heater core tubes to firewall seals (1 large, 1 small)	N/A	N/A
05	70-74 E Body & 71-74 (late) B Body non A/C heater box to cowl seal (1/2" thick "D" shaped black foam rubber)	ELB7074HB21	\$6.00
06a	70-74 E Body & 71-74 (late) B Body non A/C heater box blower motor to firewall seal (black foam rubber, large hole black foam, typically 72-74)	ELB7074HB22	\$4.00
07	Generic white strip caulk	N/A	N/A
08	Door foams (charcoal foam)	N/A	N/A
09	Door foams (charcoal foam)	N/A	N/A
10	Fresh air door foams (charcoal foam)	N/A	N/A
11	Door anti rattle bushings (4pcs thick white poly foam)	N/A	N/A
12	Black cardboard floor vent deflector	ELB7074HB24	\$10.00
13	71-74 (late) B Body Non A/C blower motor to heater box cooling tube	BXX7174BT01	\$29.00
14	71-74 (late) B Body Non A/C heater box box half and rear cardboard attaching clip set (5 small clips)	BXX7174HB02	\$5.00



# B Body 71-74

A/C Heater Box Resto Kit BXX7174HB10 \$65.00

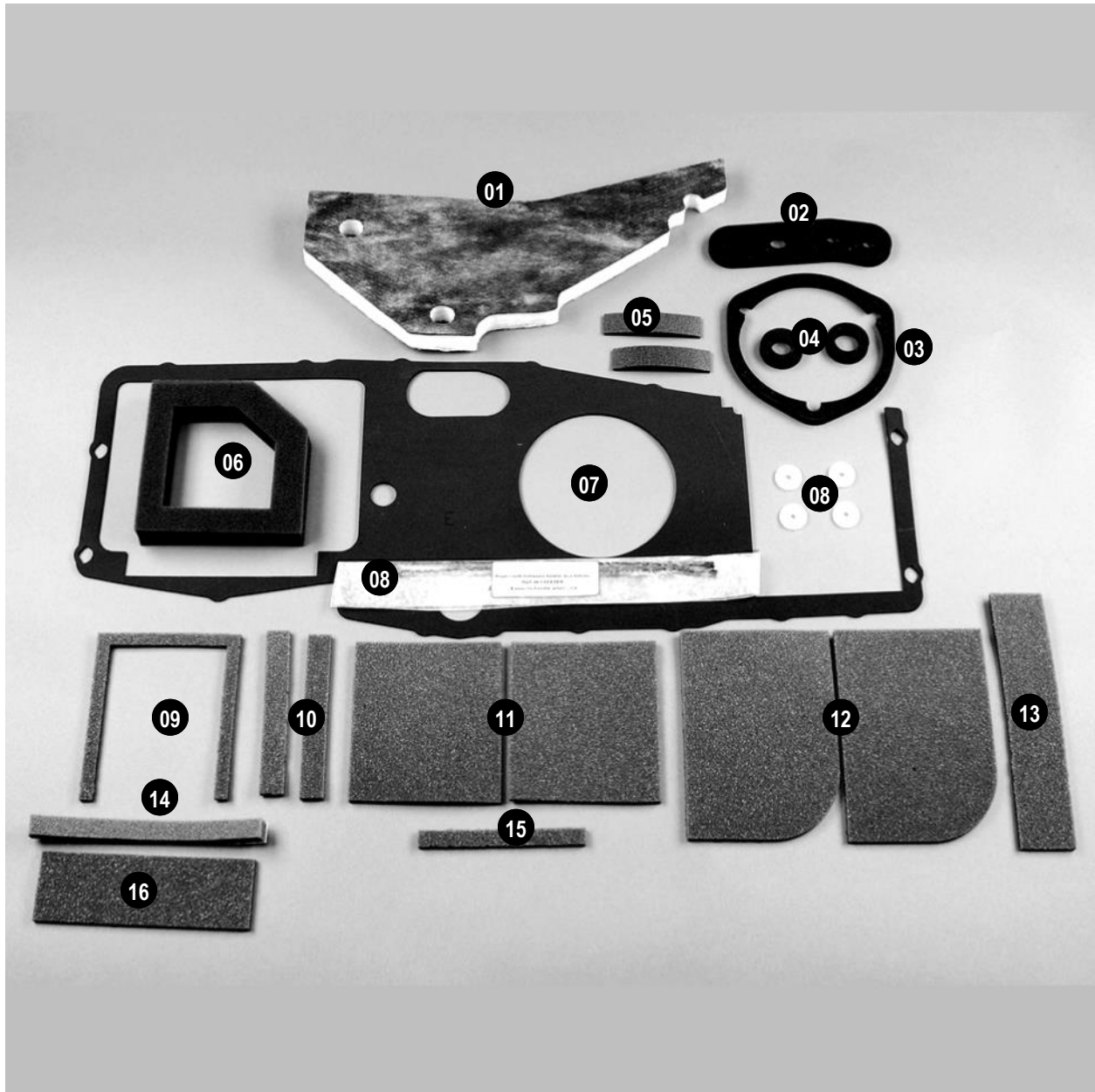

23624 Roseberry Ave Warren, MI 48089 586-777-7167 fax 586-777-7947  
[www.DetroitMuscleTechnologies.com](http://www.DetroitMuscleTechnologies.com)

## B Body 71-74

### A/C Heater Box Gasket Set

01	70-74 E Body & 71-74 (late) B Body non A/C heater box to firewall mat faced fiberglass insulation piece	ELB7074HB31	\$7.00
02	70-74 E Body & 71-74 (late) B Body A/C evaporator tubes to firewall seal (black foam rubber)	ELB7074HB32	\$6.00
03	70-74 E Body & 71-74 (late) B Body A/C blower motor to firewall seal (black foam rubber)	ELB7074HB33	\$8.00
04	70-74 E Body & 71-74 (late) B Body A/C blower motor to firewall drain seals (black foam rubber donuts)	N/A	N/A
05	71-74 (late) B Body A/C evaporator tubes to bracket anti rattle foam (black poly foam strips)	N/A	N/A
06	71-74 (late) B Body A/C heater box to windshield duct foam seal (thick coarse charcoal foam)	BXX7174HB34	\$6.00
07	71-74 (late) B Body A/C box half seal (black foam rubber)	BXX7174HB35	\$18.00
08	Firewall stud seal(4pcs white poly donut)	N/A	N/A
09	Outlet housing to box foam seal (charcoal foam)	N/A	N/A
10	Foam strips (charcoal foam)	N/A	N/A
11	Door foams (charcoal foam)	N/A	N/A
12	Fresh air door foams (charcoal foam)	N/A	N/A
13	Front access plate foam sealing strip (charcoal foam)	N/A	N/A
14	Fresh air door hinge sealing foam strip (charcoal foam)	N/A	N/A
15	Foam sealing strip (charcoal foam)	N/A	N/A
16	Foam piece (charcoal foam)	N/A	N/A





# B Body 71-74

**BIG A/C Heater Box Resto Kit BXX7174HB11 \$99.00**

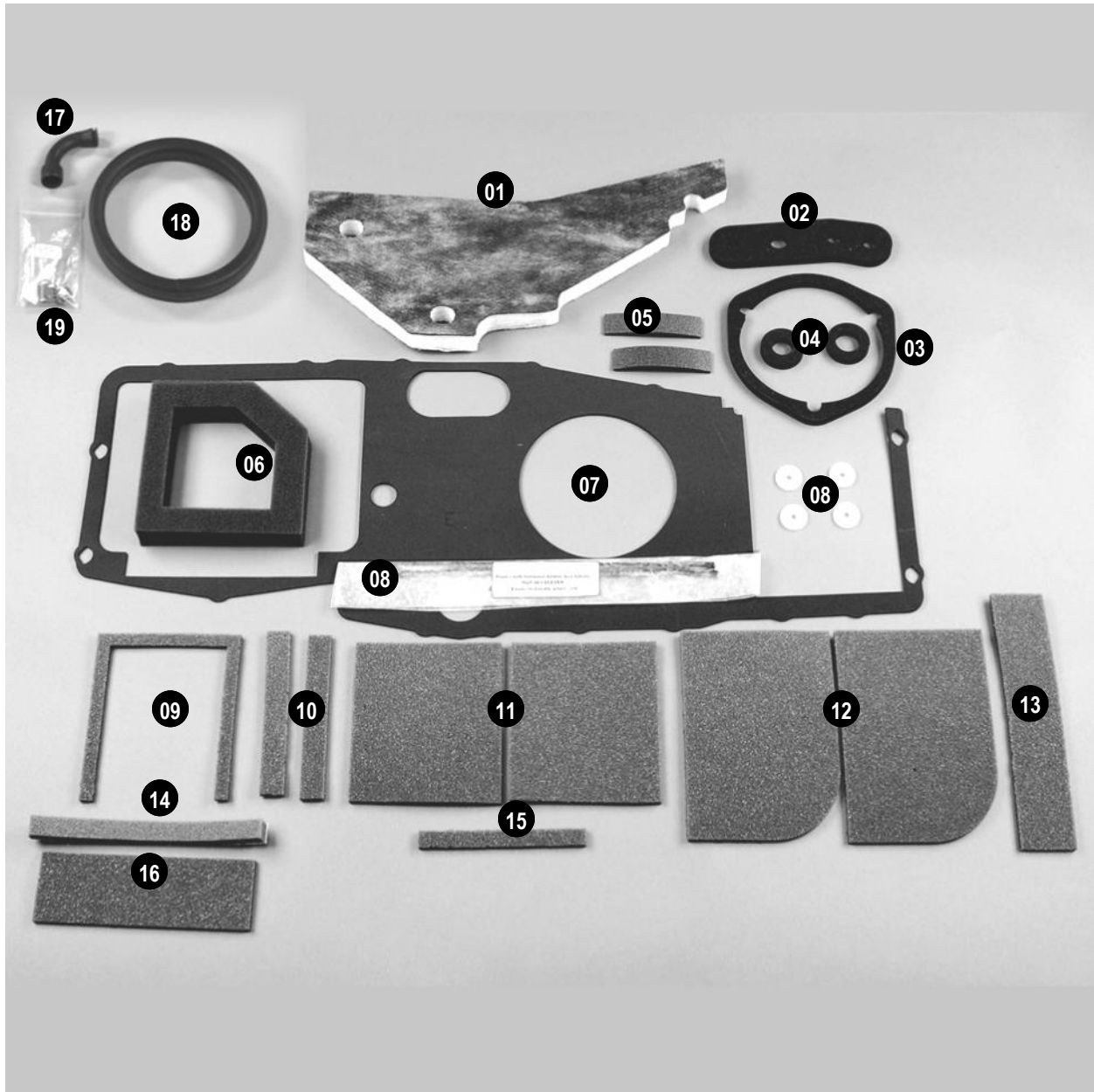

23624 Roseberry Ave Warren, MI 48089 586-777-7167 fax 586-777-7947  
[www.DetroitMuscleTechnologies.com](http://www.DetroitMuscleTechnologies.com)

## B Body 71-74

### BIG A/C Heater Box Gasket Set

01	70-74 E Body & 71-74 (late) B Body non A/C heater box to firewall mat faced fiberglass insulation piece	ELB7074HB31	\$7.00
02	70-74 E Body & 71-74 (late) B Body A/C evaporator tubes to firewall seal (black foam rubber)	ELB7074HB32	\$6.00
03	70-74 E Body & 71-74 (late) B Body A/C blower motor to firewall seal (black foam rubber)	ELB7074HB33	\$8.00
04	70-74 E Body & 71-74 (late) B Body A/C blower motor to firewall drain seals (black foam rubber donuts)	N/A	N/A
05	71-74 (late) B Body A/C evaporator tubes to bracket anti rattle foam (black poly foam strips)	N/A	N/A
06	71-74 (late) B Body A/C heater box to windshield duct foam seal (thick coarse charcoal foam)	BXX7174HB34	\$6.00
07	71-74 (late) B Body A/C box half seal (black foam rubber)	BXX7174HB35	\$18.00
08	Firewall stud seal(4pcs white poly donut)	N/A	N/A
09	Outlet housing to box foam seal (charcoal foam)	N/A	N/A
10	Foam strips (charcoal foam)	N/A	N/A
11	Door foams (charcoal foam)	N/A	N/A
12	Fresh air door foams (charcoal foam)	N/A	N/A
13	Front access plate foam sealing strip (charcoal foam)	N/A	N/A
14	Fresh air door hinge sealing foam strip (charcoal foam)	N/A	N/A
15	Foam sealing strip (charcoal foam)	N/A	N/A
16	Foam piece (charcoal foam)	N/A	N/A
17	70-74 E body & 71-74 (late) B Body A/C blower motor to heater box cooling tube	ELB7074BT01	\$19.00
18	70-74 E body & 71-74 (late) B Body A/C O-Ring / lube kit	GEN6276OR01	\$6.00
19	70-74 E body, 71-74 B Body A/C & 66-70 B Body Non A/C heater box to cowl seal (sponge rubber exactly like OEM)	GEN6674HB01	\$15.00



# B Body 71-74

## Hood & cowl seals

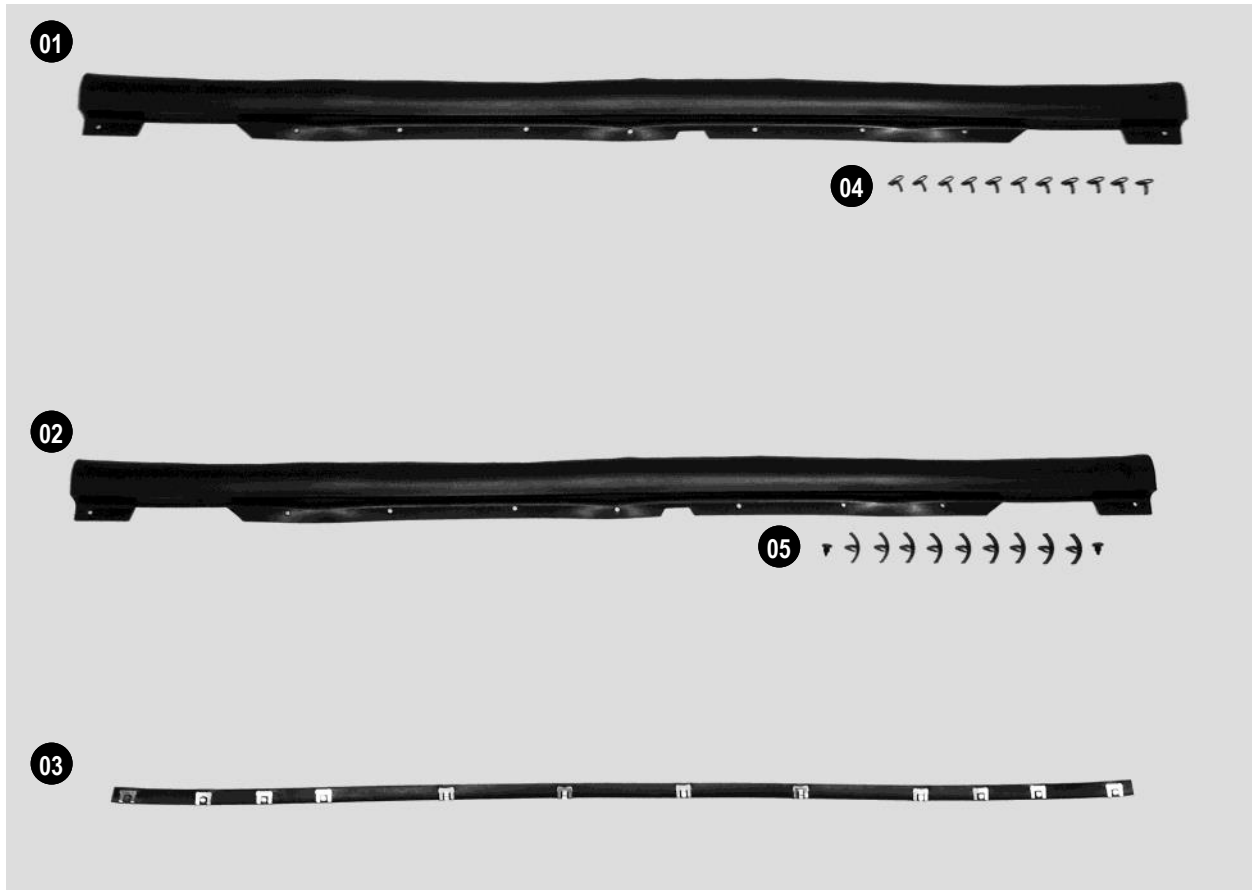

<b>01</b>	<b>B Body 71-72 Hood to radiator seal</b> with (11) OEM style black painted "D" shaped, <b>STAINLESS STEEL</b> clips	<b>BXX7172HS01</b>	<b>\$45.00</b>
<b>02</b>	<b>B Body 73-74 Hood to radiator seal</b> with (9) OEM style curved plastic clips and (2) push pins	<b>BXX7374HS01</b>	<b>\$45.00</b>
<b>03</b>	<b>B Body 71-74, E Body 70-74 Hood to cowl seal</b> With OEM style <b>STAINLESS STEEL</b> clips already installed	<b>ELB7074CS01</b>	<b>\$35.00</b>
<b>04</b>	<b>D shaped black plated STAINLESS STEEL hood to radiator clips EACH</b>	<b>GEN6772HS01-1</b>	<b>\$1.00</b>
<b>05</b>	<b>Plastic hood to radiator seal and hood pad clips - EACH</b>	<b>6003351 -1</b>	<b>\$0.50</b>

# B Body 71-74

## Door & pillar end seals



ALP7014

\$37.00

**B Body 71-74 door end seal by FRONT HINGE**  
This is a 71-74 B body ONLY piece



ALP7016

\$45.00

**B Body 71-72 Dodge door end seal**



ALP7011

\$45.00

**B Body 71-4 Plymouth, 73-74 Dodge door end seal**



ALP7013

\$42.00

**B Body 71-72 Dodge pillar seal**

## B Body 71-74

### Door & pillar end seals



**ALP7012**

**\$32.00**

**B Body 71-74 Plymouth, 73-74 Dodge pillar seal**  
(See ALP7013 for 71-72 B bodies)

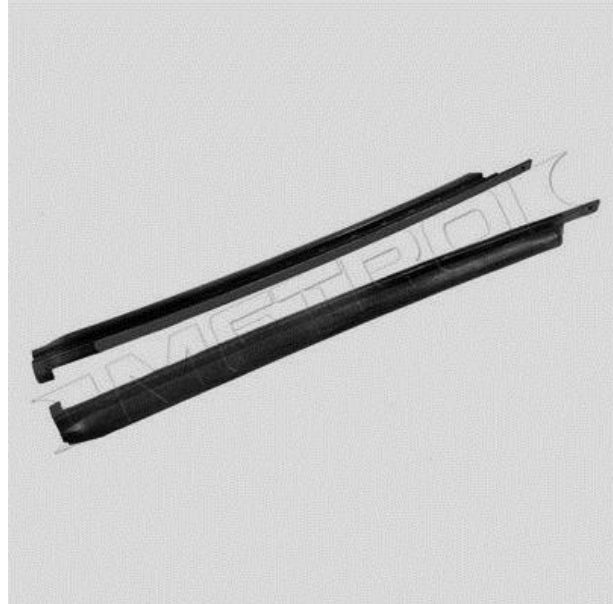

**VS7-F**

**\$35.00**

**B Body 71-74 rear qtr window leading edge seal**

# B Body 71-74

## Weatherstripping



**LM23-D** \$75.00  
B Body 71-74 Door Seals with clips



**RR4002** \$75.00  
B Body 71-74 Roof rail seals  
EXCEPT 73-74 Charger SE



**TK64-A/18** \$17.00  
B Body 71-72 18' "Y" shaped trunk seal



**TK56-B/18** \$25.00  
B Body 73-74 "D" shaped trunk seal

# B Body 71-74

## Weatherstripping



**LM23-D** **\$75.00**  
**B Body 71-74 Door Seals with clips**



**RR4002** **\$75.00**  
**B Body 71-74 Roof rail seals**  
EXCEPT 73-74 Charger SE

**Photo  
Coming**



**XXRKB4005-106A (special part# early trunk)** **\$165.00**  
**B Body 71-72 5pc weatherstrip seal set**  
LM23-D Door Seal, RR4002 roof rail seals, 18' "Y" shaped trunk seal

**RKB4005-106** **\$165.00**  
**B Body 73-74 5pc weatherstrip seal set**  
LM23-D Door Seal, RR4002 roof rail seals, 18' "D" shaped trunk seal

## B Body 71-74

### B Body 71-74 DODGE beltline weatherstrips (cat whiskers)

01

02

03

04

05

06

07

Photo  
Coming

01	B Body 71-72 Charger beltline weatherstrip set 10pc	200802	\$160.00
02	B Body 71-72 Charger RT beltline weatherstrip set 10pc	200806 *	\$160.00
03	B Body 72 Charger SE beltline weatherstrip set 10pc	200807 *	\$160.00
04	B Body 73-74 Charger SE OUTSIDE stainless bead beltline weatherstrip set 4pc	200803 *	\$110.00
05	B Body 73-74 Charger SE OUTSIDE black bead beltline weatherstrip set 4pc	200803B *	\$110.00
06	B Body 73-74 Dodge stainless bead beltline weatherstrip set 10pc	200805	\$160.00
07	B Body 73-74 Dodge black bead beltline weatherstrip set 10pc	200805B *	\$160.00



23624 Roseberry Ave Warren, MI 48089 586-777-7167 fax 586-777-7947  
[www.DetroitMuscleTechnologies.com](http://www.DetroitMuscleTechnologies.com)



# B Body 71-74

## Hood insulation pads



**EXX7074HP02**

**\$35.00**

**E Body 72-74 (and 71-74 Charger) Hood insulation pad**  
1/2" thick, 2pcf density very close to OEM molded hood pad  
thickness and density for a fraction of the cost.  
(20) OEM style plastic clips

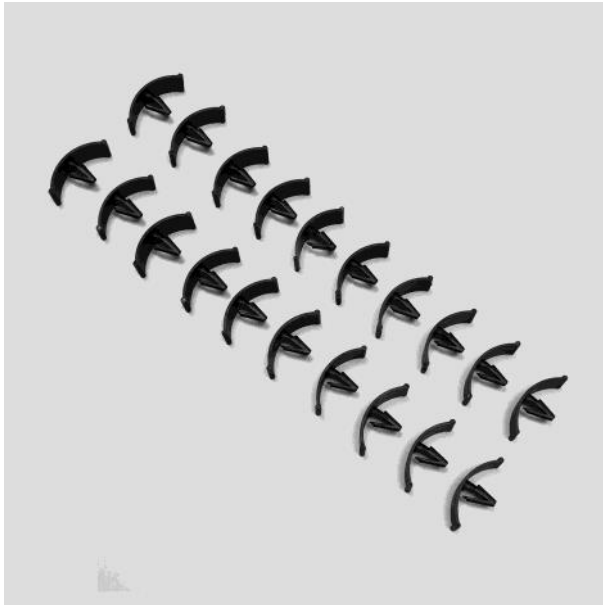

**DMT6003351-20**

**\$8.00**

**PLASTIC 72-up hood insulation clips - 20pcs**  
Also used on some 73-up hood to radiator seals



23624 Roseberry Ave Warren, MI 48089 586-777-7167 fax 586-777-7947  
[www.DetroitMuscleTechnologies.com](http://www.DetroitMuscleTechnologies.com)

# B Body 71-74

## Body bumper & body plug sets



**BXX7172BB01 - BBK6A** \$35.00

**B Body 71-72 Body bumper set**  
All hood, door, deck lid, etc body bumpers



**BXX7374BB01 - BBK16** \$35.00

**B Body 73-74 Body bumper set**  
All hood, door, deck lid, etc body bumpers

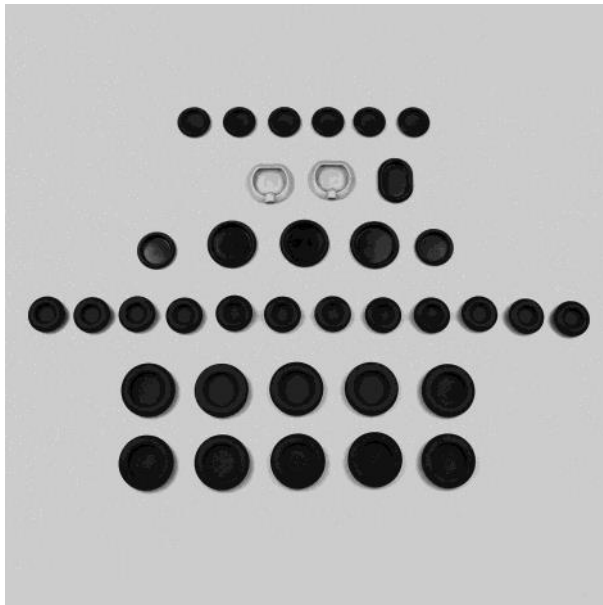

**BXX7172BP01 - BPK14** \$35.00

**B Body 71-72 Body plug set**  
All floor, trunk, qtr panel, etc body plugs

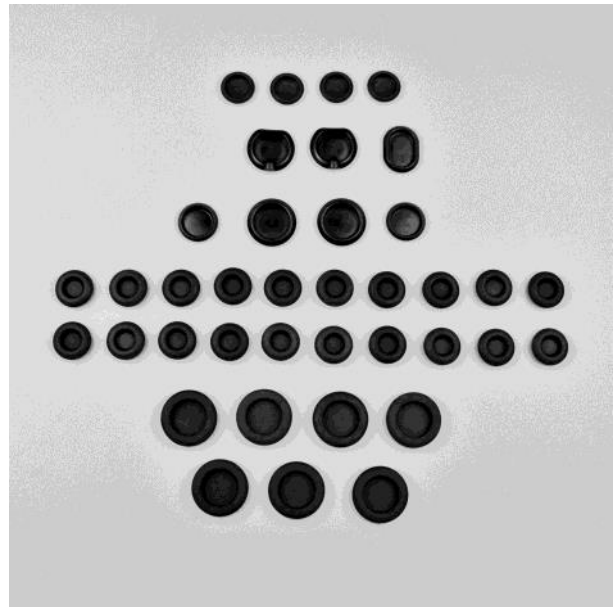

**BCH7374BP01 - BPK16** \$35.00

**73-74 Charger body plug set**  
All floor, trunk, qtr panel, etc body plugs

## B Body 71-74

### Gas tank pads



**BXX7173TP01**

**\$18.00**

**B Body 71-73 Tank pad**

.070" thick felt paper. Closest to OEM.

OEM was waffled brown asbestos felt which is unavailable.

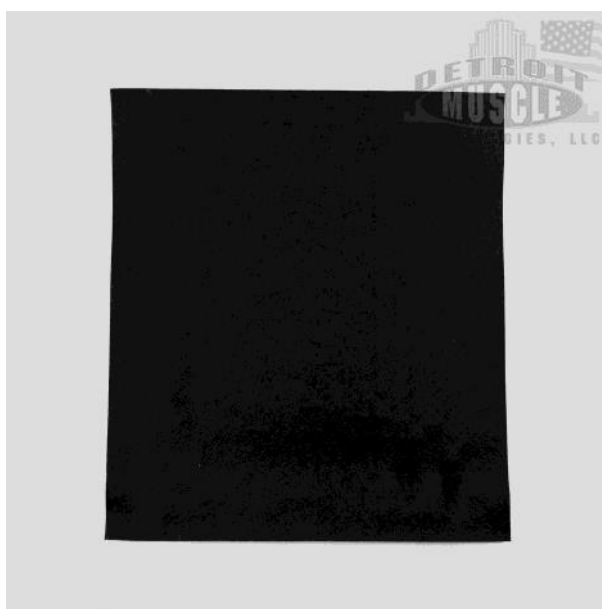

**BXX7173TP02**

**\$24.00**

**B Body 71-73 Tank pad**

.090" thick masticated rubber.

Heavy, better sound damping than OEM

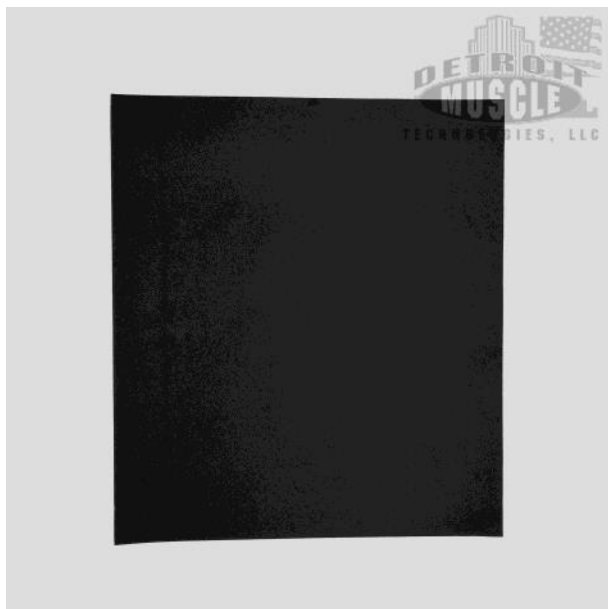

**BXX7173TP03**

**\$16.00**

**B Body 71-73 Tank pad**

.250" thick foam rubber.

Economical



23624 Roseberry Ave Warren, MI 48089 586-777-7167 fax 586-777-7947  
[www.DetroitMuscleTechnologies.com](http://www.DetroitMuscleTechnologies.com)

# B Body 71-74

## Gas tank pads

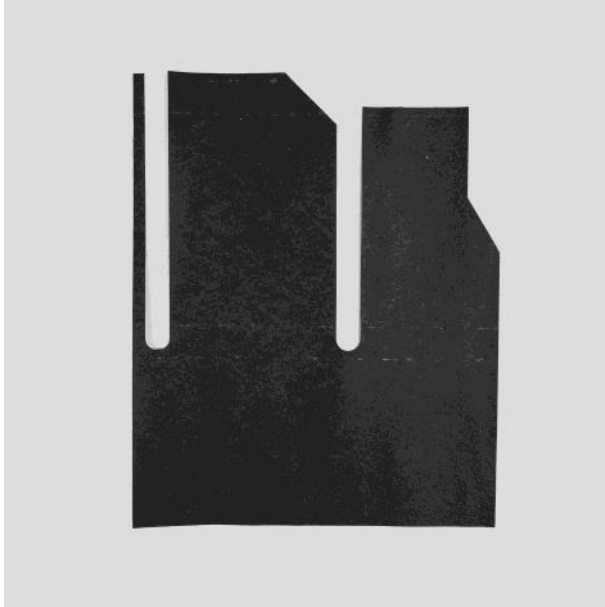

**BXX7476TP01**

**\$18.00**

**B Body 74-76 Tank pad (with hump in trunk)**

.070" thick felt paper. Closest to OEM.

OEM was waffled brown asbestos felt which is unavailable.

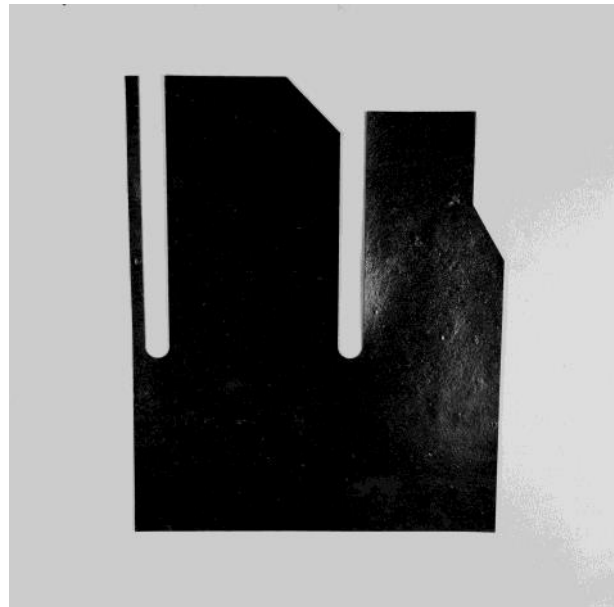

**BXX7476TP02**

**\$24.00**

**B Body 74-76 Tank pad (with hump in trunk)**

.090" thick masticated rubber.

Heavy, better sound damping than OEM

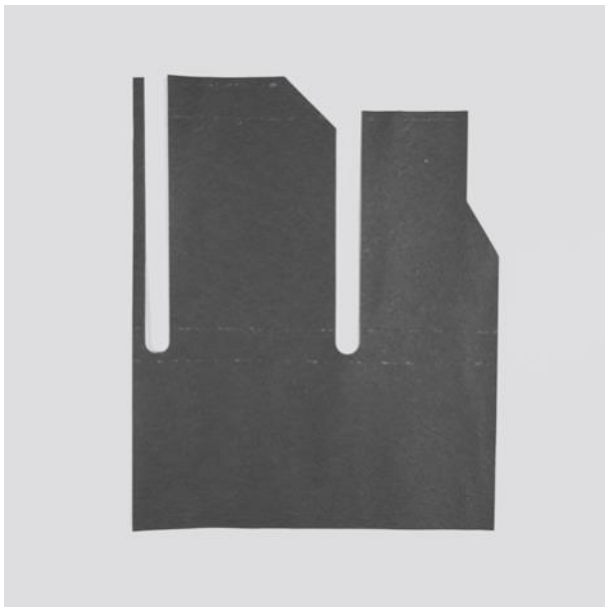

**BXX7476TP03**

**\$16.00**

**B Body 74-76 Tank pad (with hump in trunk)**

.250" thick foam rubber.

Economical



23624 Roseberry Ave Warren, MI 48089 586-777-7167 fax 586-777-7947  
[www.DetroitMuscleTechnologies.com](http://www.DetroitMuscleTechnologies.com)

## B Body 71-74

### Trunk divider (between rear seat & trunk)

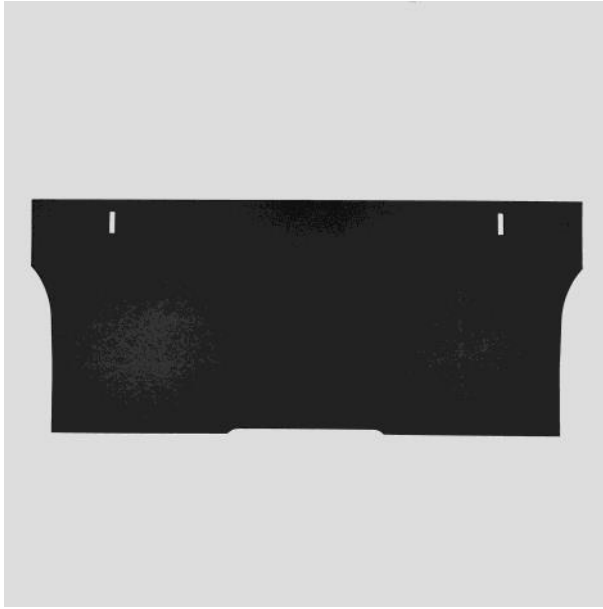

**BXX7174TD01**

**\$25.00**

**B Body 71-74 Rear set trunk divider**  
.110" heavy black chipboard like OEM



**BXX7174TD02**

**\$45.00**

**B Body 71-74 Rear set trunk divider with insulation**  
.110" heavy black chipboard like OEM with 3/8" shoddy sound insulation attached.

## B Body 71-74

misc

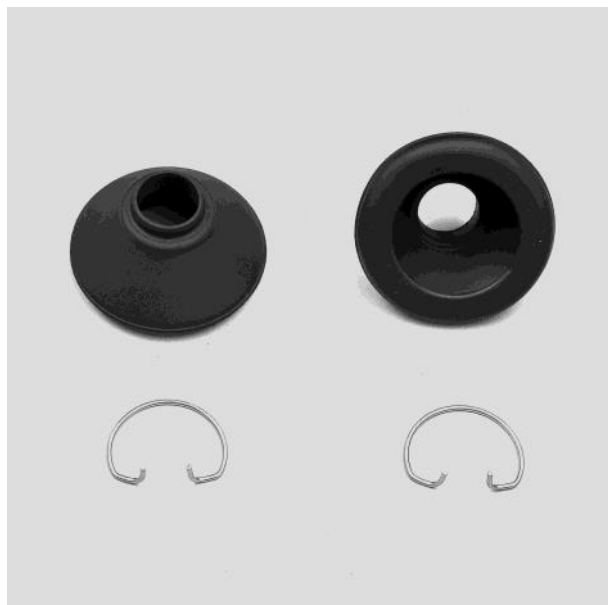

**GEN6676TB01**

**\$29.00**

**A 62-76, B 62-72, E 70-74 Torsion bar boots with STAINLESS STEEL clips**

Will not fit C body or 73-74 B Body



**GEN6676SC01**

**\$14.00**

**3" STAINLESS STEEL Steering coupler cover clamp / retainer**

Fits all 66-76 A body, 66-72 B Body and 70-72 E Body 3" long power AND manual steering couplers



**GEN7373SC01**

**\$14.00**

**3-1/2" STAINLESS STEEL Steering coupler cover clamp / retainer**

Fits all 75-76 B Body and 73-74 E Body 79-93 Dodge Truck 3-1/2" long power AND manual steering couplers



**GEN6676SC10**

**\$32.00**

**3" STAINLESS STEEL Steering coupler cover clamp, STAINLESS STEEL cover & seal**

Fits all 66-76 A body, 66-72 B Body and 70-72 E Body 3" long power AND manual steering couplers

## B Body 71-74

### misc



**GEN7376SC11** **\$32.00**

**3-1/2" STAINLESS STEEL Steering coupler cover clamp, STAINLESS STEEL cover & seal**

Fits all 75-76 B Body and 73-74 E Body 3-1/2" long power AND manual steering couplers



**GEN6276AC01**

**\$6.00**

**Air cleaner lid seal**

All 62-76 models—56" long

Will fit everything from a 6cyl to a dual snorkel



**ELB7074TG01** **\$14.00**

**Generic fuel/ gas tank grommet**

70 B Body, 71-74 B Body, 70-74 E body

# B Body 71-74

## console woodgrain & carbon fiber vinyl overlays

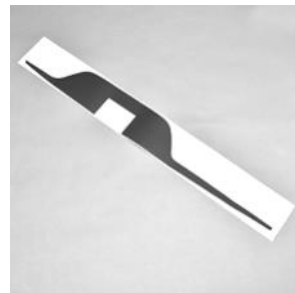
			
<p><b>ELB7074WG01</b>      <b>\$30.00</b></p> <p><b>Auto console woodgrain overlay</b> 70-74 Barracuda, Challenger 71-74 Charger, Satellite with instructions</p>	<p><b>ELB7074WG02</b>      <b>\$30.00</b></p> <p><b>4 speed console woodgrain overlay</b> 70-74 Barracuda, Challenger 71-74 Charger, Satellite with instructions</p>	<p><b>EXX7074CF01</b>      <b>\$30.00</b></p> <p><b>70-74 E body auto console PREMIUM Carbon Fiber Vinyl Overlay</b> with instructions</p>	<p><b>EXX7074CF02</b>      <b>\$30.00</b></p> <p><b>70-74 E body 4 speed console PREMIUM Carbon Fiber Vinyl Overlay</b> with instructions</p>
<p><b>NOTE:</b> These overlays are 8mil (.008") premium, exterior architectural grade embossed vinyl. Not some cheap craft store vinyl.</p> <p><b>To Install</b> Remove old overlay. Sand surface smooth if required (any imperfections will show through). Clean surface with alcohol. Spray surface with Windex enough that overlay can be slid into position. Pat / squeegee with a towel to remove air bubble and excess Windex. Use a hair dryer to dry edges and to soften material press down into holes on E body dashes.</p> <p><b>Important</b> <b>Keep out of direct sunlight and away from heat until installed.</b></p>			



