

# 67-72 A BODY HEATER BOX

INCLUDED IN KIT:

ALL FOAMS, SEALS AND GASKETS SHOWN BELOW

60" WHITE ROPE CAULK TO SEAL BOX HALVES

(1) 1-1/2"L x 1/2"ID BLACK NEOPRENE FOAM TUBE INSULATION - SMALL HEATER CORE TUBE SEAL TO FIREWALL  
 (2) 1-1/2"L x 5/8"ID BLACK NEOPRENE FOAM TUBE INSULATION - LARGE HEATER CORE TUBE SEAL TO FIREWALL

(NOTE: (2) 5/8"ID ON SOME 72 AND 75-76, (1) 1/2"ID & (1) 5/8"ID ON ALL OTHERS)

(1) 1/2" X 1/2" x 22" ADHESIVE BACKED SPONGE RUBBER STRIPS - HEATER BOX TO COWL SEAL

NOT INCLUDED (INFORMATIONAL PURPOSES ONLY)

(9) #10x5/8" PLAIN HEX HEAD SCREWS - USED EVERYWHERE ON 75 & 76 BOXES ONLY

(6) #10x1/2" PHILIPS HEAD SCREWS - (4) HEATER CORE TO HOUSING, (2) BLOWER RESISTOR

(1) #10X5/8" PHILIPS HEAD SCREW - HEATER CORE TUBE SEAL PLATE TO HOUSING

(7) SMALL 1/2"W "U" SHAPED CLIPS - TO HOLD CENTER VENT CARDBOARD TO BOX

(9) LARGE 1"W BOX HALF CLIPS

HEATER TUBE FIREWALL SEAL  
 1.625"H x 2.75"W .1/8" NEOPRENE

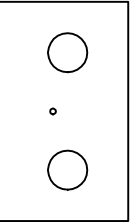

HEATER TUBE TO HEATER BOX  
 1.375"H x 2.75"W .1/8" NEOPRENE

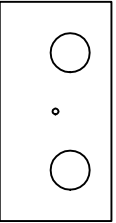

(66-76 HEATER BOXES)  
 BACK PLATE TO HOUSING SEAL  
 3.5" X .50" X .25" WHITE POLY



HOT AIR DOOR (2 VERSIONS)

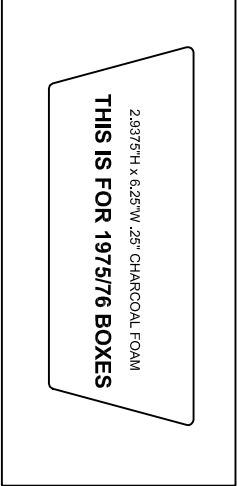

2.9375"H x 6.25"W .25" CHARCOAL FOAM  
**THIS IS FOR 1975/76 BOXES**

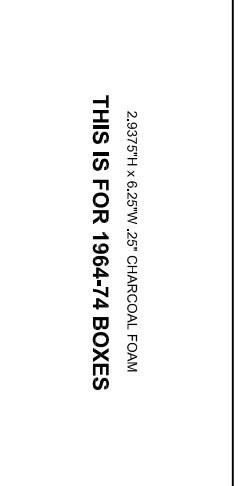

2.9375"H x 6.25"W .25" CHARCOAL FOAM  
**THIS IS FOR 1964-74 BOXES**

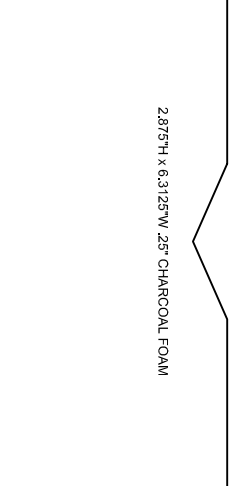

2.875"H x 6.3125"W .25" CHARCOAL FOAM

## THESE ARE STRIPS OF ADHESIVE BACKED FOAM TAPE

7"H x .57" X .375"  
 APPLIES TO SIDE OF HEATER CORE  
 TO SEAL HOT AIR DOOR SHAFT

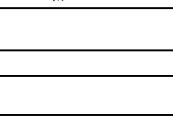

A BODY BLOWER GASKET  
 2.9375"OD x 1.4"ID x .060"TT  
 WITH (2) .1679 HOLES ON A 2.25" CIRCLE  
 TAN GASKET MATERIAL

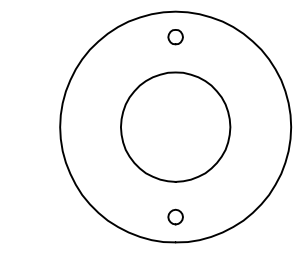

3.50"H X .57" X .375"  
 APPLIES TO THE INSIDE OF THE METAL PLATE  
 ON THE REAR OF THE HEATER BOX TO SEAL  
 THE SHAFT OF THE MIDDLE DOOR WITH THE  
 TRAPAZOIDAL FOAMS  
 (THIS MAY BE 64-65 ONLY)

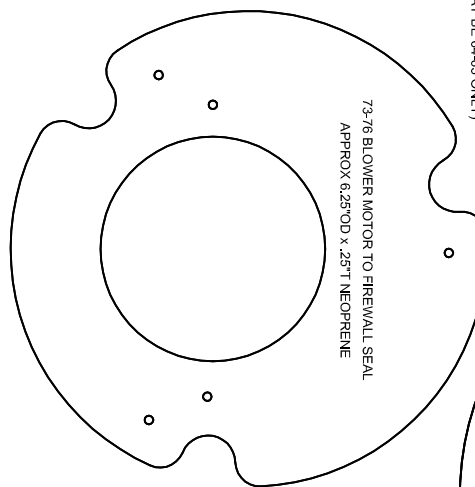
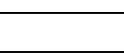

75-76 BLOWER MOTOR TO FIREWALL SEAL  
 APPROX 6.25"OD x .25"TT NEOPRENE

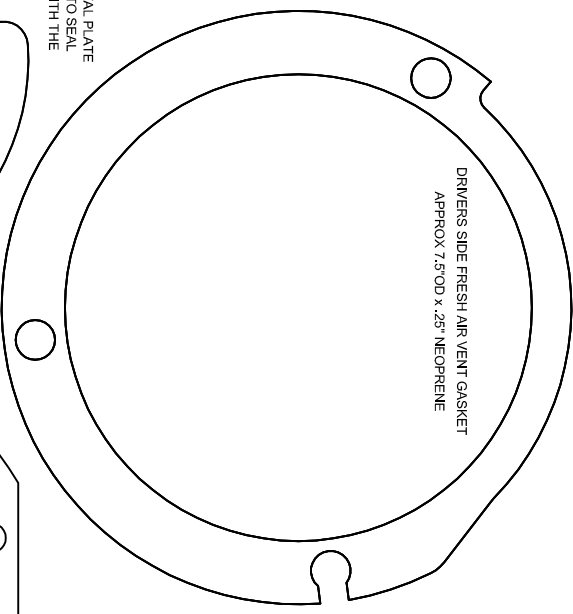

DRIVERS SIDE FRESH AIR VENT GASKET  
 APPROX 7.5"OD x .25" NEOPRENE

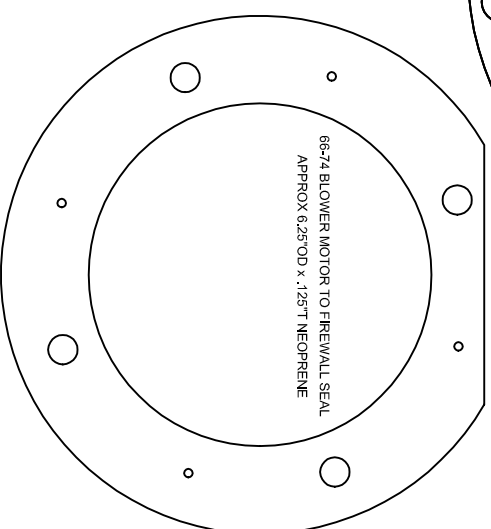

66-74 BLOWER MOTOR TO FIREWALL SEAL  
 APPROX 6.25"OD x .125"TT NEOPRENE

HEAT/DEFROST DOOR

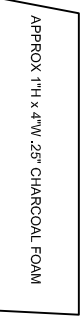

APPROX 1"H x 4"W .25" CHARCOAL FOAM

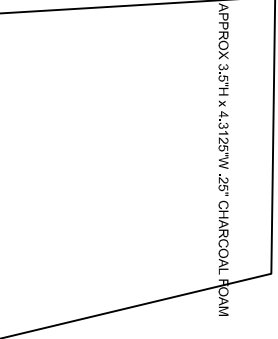

APPROX 3.5"H x 4.3125"W .25" CHARCOAL FOAM

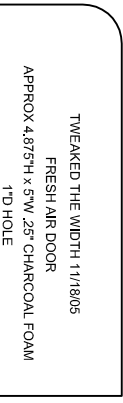

TWEAKED THE WIDTH 11/18/05  
 FRESH AIR DOOR  
 APPROX 4.875"H x 5"W .25" CHARCOAL FOAM  
 1"ID HOLE

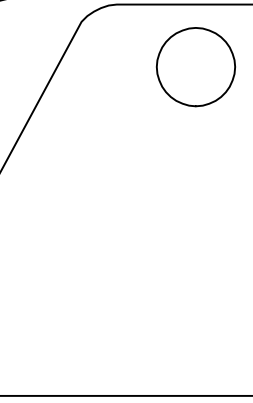

DRIVERS SIDE  
 FRESH AIR DOOR

